

DEPARTMENT OF THE ARMY TECHNICAL MANUAL

ORGANIZATIONAL, DS, GS AND DEPOT
MAINTENANCE MANUAL

HEWLETT-PACKARD NOISE
FIGURE METER
MODEL 342A AND NOISE
SOURCE MODEL 349A

HEADQUARTERS, DEPARTMENT OF THE ARMY
SEPTEMBER 2, 1967

WARNING

DANGEROUS VOLTAGES

EXIST IN THIS EQUIPMENT

Be careful when working on the power supplies and their circuits, or on the 115-volt ac line connections.

DON'T TAKE CHANCES!

This manual contains copyright material reproduced by permission of Hewlett-Packard Company, Palo Alto, California

Technical Manual)

No. 11-6625-1613-15)

HEADQUARTERS,
DEPARTMENT OF THE ARMY
Washington, D.C., 19 September 1967

ORGANIZATIONAL, DS, GS, AND DEPOT MAINTENANCE MANUAL
HEWLETT-PACKARD NOISE FIGURE METER MODEL 382A
AND NOISE SOURCE MODEL 349A

	Paragraph	Page
Section I. GENERAL INFORMATION		
Scope	1-A.1	1-1
Index of publications	1-A.2	1-1
Forms and records	1-A.3	1-1
General description	1-1	1-3
Noise sources	1-2	1-3
II. OPERATING INSTRUCTIONS		
Introduction.....	2-1	2-1
Controls and terminals	2-2	2-1
Relative noise figure measurements.....	2-3	2-2
Warm-up	2-4	2-2
Meter movement mechanical zero	2-5	2-2
Operating procedures	2-6	2-2
Use of an external meter.....	2-7	2-10
Meter offset	2-8	2-10
Improving low NF measurement accuracy.....	2-9	2-11
Sources of error 10	2-10	2-12
Image considerations in receiver NF measurements.....	2-11	2-13

	Paragraph	Page
Section III. THEORY OF OPERATION		
Introduction.....	3-1	3-1
Measurement of noise figure.....	3-2	3-1
Over-all operation.....	3-3	3-1
RF amplifier, mixer and local oscillator	3-4	3-2
TF amplifier, detector, video amplifier and dc restorer.....	3-5	3-2
Switching circuits.....	3-6	3-2
Noise source power supply	3-7	3-3
AGC gate and integrator	3-8	3-3
Meter gate and integrator.....	3-9	3-3
Manual operation.....	3-10	3-4
IV. MAINTENANCE		
Cabinet removal	4-1	4-1
Connection for 230 volt operation	4-2	4-1
Over-all performance check	4-3	4-1
Tube replacement	4-4	4-4
Adjustments	4-5	4-4
Checking meter tracking	4-6	4-5
Trouble localization	4-7	4-8
V. NOISE, SOURCE MODEL 349A		
Introduction.....	5-1	5-1
General operating information	5-2	5-1
Operation.....	5-3	5-3
Principles of operation.....	5-4	5-3
Performance checks	5-5	5-3

Model 342A

SPECIFICATIONS

Noise Figure Range:

5.2 db noise source 0 to 15 db, indication to infinity

15.2 db noise source 3 to 30 db, indication to infinity

Accuracy: (excluding source accuracy)

Noise Diode Scale: +1/2 db, 0 to 15

Gas Tube Scale: +1/2 db, 10 to 25

+ 1 db, 3 to 10

and 25 to 30

Input Frequency:

30, 60, 70, 105 and 200 mc, selected by switch.

Other frequencies optional.

Bandwidth: 1 mc minimum

Input:

-60 to 10 dbm (noise source on). Corresponds to gain between noise source and 34; of:

5.2 db noise source approx. 50 to 100

15.2 db noise source approx. 40 to 90 db

Input Impedance: 50 ohms nominal

AGC Output:

Nominally 0 to 6v from rear binding posts

Recorder Output:

1 ma maximum into 2000 ohms maximum

Power Input:

115/230v +10%, 50-60cps, 185 to 435 watts depending on noise source and line voltage

Power Output:

Will operate 343A, 345B, 347A or 349A

noise sources

Dimensions:

Cabinet Mount:

high, 14-1/2 in. deep

Rack Mount:

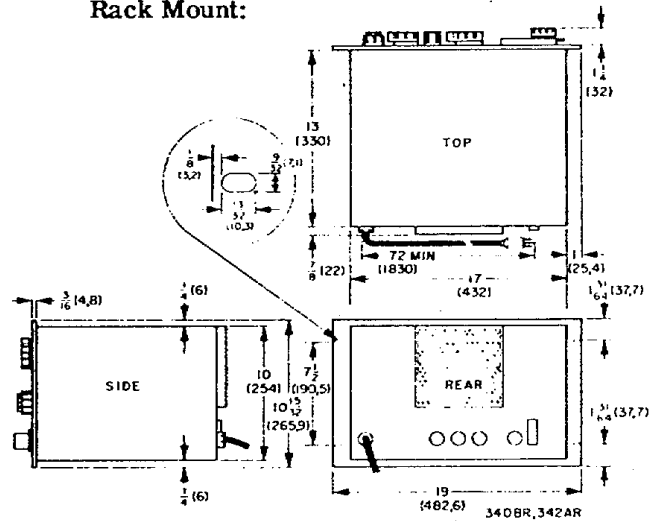

Weight:

Cabinet Mount: Net 40 lbs, shipping 51 lbs

Rack Mount: Net 34 lbs, shipping 49 lbs

Accessories Furnished:

340A-16A, 6 ft cable for connecting r 342A to 1 349A or to any . 347A noise source

Accessories Available:

343A VHF Noise Source, 10 to 600 mc

345B IF Noise Source, 30 to 60 mc

347A Waveguide Noise Source for S, G, J, H, X and P bands

349A UHF Noise Source, 400 to 4000 mc,

Type N connectors

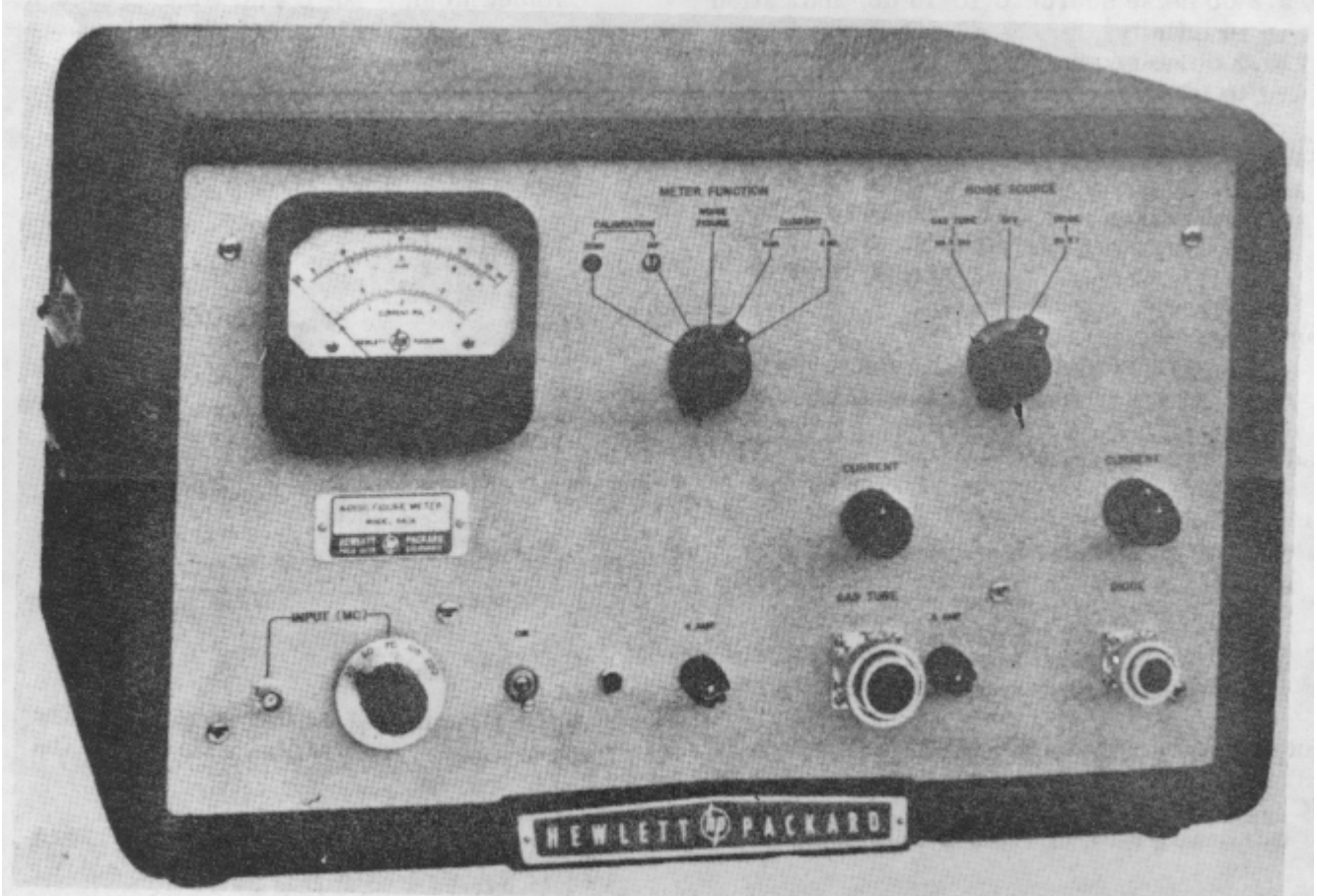

Figure 1-1. Model 342A Noise Figure Meter

SECTION I GENERAL INFORMATION

1-A.1. Scope

a. This manual includes installation and operation instructions and covers operator's, organizational, direct support (DS), general support (GS), and depot maintenance. It describes Hewlett-Packard (Federal supply code 28480) Noise Figure Meter 342A and Noise Source Model 349A.

b. A basic issue items list for this equipment is not included as part of this manual.

1-A.2. Index of Publications.

Refer to the latest issue of DA Pam 310-4 to determine whether there are new editions, changes, or additional publications pertaining to the equipment.

1-A.3. Forms and Records

a. Reports of Maintenance and Unsatisfactory Equipment. Use equipment forms and records in accordance with instructions given in TM 38-750.

b. Report of Packaging and Handling Deficiencies. Fill out and forward DD Form 6 (Report of Packaging and Handling Deficiencies) as prescribed in AR 700-58 (Army), NAVSUP Publication 378 (Navy), AFR 71-4 (Air Force), and MCO P4610-5 (Marine Corps).

c. Discrepancy in Shipment Report (DISREP) (SF361). Fill out and forward Discrepancy in Shipment Report (DISREP) (SF361) as prescribed in AR 55-38 (Army), NAVSUP Pub 459 (Navy), AFM 75-34 (Air Force), and MCO P4610.19 (Marine Corps).

d. Reporting of Equipment Manual Improvements. Report of errors, omissions, and recommendations for improving this manual by the individual user is encouraged. Reports should be submitted on DA Form 2028 (Recommended Changes to DA Publications) and forwarded direct to Commanding General, U. S. Army Electronics Command, ATTN: AMSEL-ME-NMP-AD, Fort Monmouth, N. J. 07703.

1-1 GENERAL DESCRIPTION

Model 342A Noise Figure Meter with an appropriate noise source automatically measures and continuously displays the noise figure of the receiver or amplifier to which it is attached. Noise figure of a receiver or amplifier is a measure of deterioration of the signal-to-noise ratio, caused by the amplifying device. Specifically, noise figure is the signal-to-noise ratio at the input of the device divided by the signal-to-noise ratio at the output of the device, and is expressed in db.

The Model 342A Noise Figure Meter is designed for use with radar and other microwave receivers which have an intermediate frequency of 30, 60, 70, 105 or 200 mc and with amplifiers tuned to these frequencies. It may also be used with devices tuned to other frequencies and with traveling wave tube amplifiers if a converter is used to obtain one of the standard instrument frequencies.

Model 342A provides a convenient and simple method of measuring and minimizing the noise figure of receivers and amplifiers. Besides making measurements of noise figure automatically, this instrument can be used to measure noise figure by the twice power method. In this method, noise power is added to the input of the device being tested until the output power of the device is doubled. Thus, the added power is equal to the equivalent added noise at the input, and noise figure can be determined by referring the added noise to theoretical noise, KToB.

1-2 NOISE SOURCES

The Hewlett-Packard Company manufactures two types of noise sources which operate with the Model 342A The Noise Figure Meter provides both power to operate these

sources and circuitry for measuring and adjusting the noise source current.

MODEL 343A VHF NOISE SOURCE

Model 343A VHF Noise Source contains a temperature-limited diode and circuitry to obtain an excess noise of 5.2 db (nominal) at a source impedance of 50 ohms. The output noise spectrum is flat from 10 to 600 mc.

MODEL 345B IF NOISE SOURCE

The Model 345B IF Noise Source is also a temperature-limited diode. It has four output impedance as selected by a rotary switch. The noise spectrum is center tuned at 30 or 60 mc as selected by a toggle switch.

MODEL 347A WAVEGUIDE NOISE SOURCES

Each Model 347A Waveguide Noise Source consists of an appropriate section of waveguide in which is mounted an argon-filled gas-discharge tube. Accurate measurements are assured, since careful design has kept the standing-wave-ratio low in both the "on" and "off" conditions of the tube. Waveguide Noise Sources are available in S, G, J, H, X and P bands for operation from 2.6 kmc to 18.0 kmc and each covers a full waveguide band.

Model 349A Noise Source

The Model 349A Noise Source provides approximately 15.7 db excess noise for making noise-figure measurements automatically on microwave receivers, scatter communications receivers, L-band radars, parametric amplifiers, and other devices operating between 400 and 4000 mc. Measurements are accurate because both fired and unfired SWR are low. The source is usable to 200 Mc with corrections supplied.

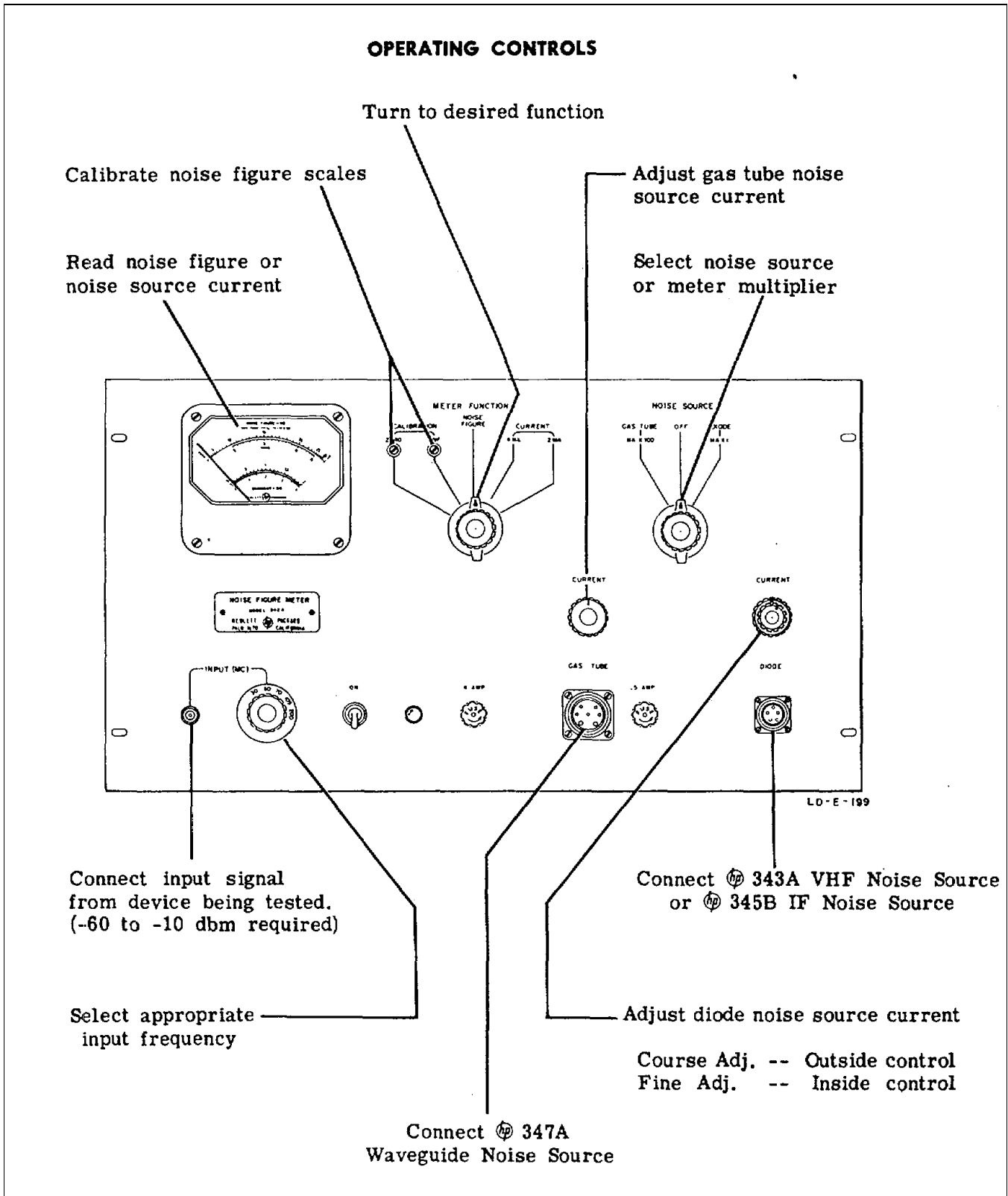

Figure 2-1.

**SECTION II
OPERATING INSTRUCTIONS****2-1 INTRODUCTION**

This section contains instructions for measuring the noise figure of microwave receivers or amplifiers tuned to 30, 60, 70, 105 and 200 mc. Two methods of measurement are illustrated. First is the automatic method by which the noise figure of the unit being tested is automatically displayed on the meter face. Second is the "twice power" or manual method where the 342A becomes a sensitive power level indicator.

2-2 CONTROLS AND TERMINALS

Besides the controls shown in Figure 2-1, there are less frequently used controls and terminals located at the rear of the unit. These are:

A. NOISE FIGURE SWITCH

In the AUTO. setting, the 342A makes continuous and automatic measurements of noise figure. In the MANUAL position the 342A is used as a power level indicator to make noise figure measurements by the "twice power" method.

B. PULSE RATE ADJ.

Adjust the free-running rate of the timing multi-vibrator, V104. Set control to any convenient position to eliminate beat effects in an over-all system, such as harmonics of the power line frequency. Such effects will be noticeable usually as wide excursion meter flutter at the beating frequency. Repositioning this adjustment in no way affects the basic accuracy or operation of the 342A.

C. RECORDER

Connect an external graphic recorder to the output jack which is in series with the meter as shown in the schematic diagram. The output circuit will supply a current, proportional to meter deflection, into a maximum of 2000 ohms. Full scale meter deflection corresponds to 1 ma output. Additional impedance of the recorder may change the meter calibration. To calibrate, check the INF. CALIBRATION, and recalibrate this point if necessary. (See Figure 2-6).

D. DIODE CURR. ADJ.

Set maximum plate current of particular diode noise source in use. Proceed as follows:

- 1) Set the CURRENT control at minimum (fully counterclockwise).
- 2) Connect the 343A or 345B Noise Source to the DIODE connector. The impedance setting of the 345B does not affect the DIODE CURR. ADJ. procedure.
- 3) Set the NOISE SOURCE switch to the DIODE-MA XI position, and the METER FUNCTION switch to the CURRENT-4 MA position.
- 4) Allow a few minutes for warmup.
- 5) Slowly rotate the CURRENT controls clockwise toward maximum while readjusting the DIODE CURR. ADJ. control to maintain the current below 4 ma.
- 6) With the CURRENT controls fully clockwise, set the DIODE CURR. ADJ. control to provide 4 ma of current.

CAUTION

The maximum plate current rating of the diode used in the 343A VHF Noise Source is only 5 ma. Incorrect adjustment of the above controls may exceed this rating. The maximum current, therefore, should always be set at 4 ma or less to prevent damage to the diode.

E. AUX. INPUT AND OUTPUT VOLTAGES

As an optional feature on the rack model 342AR, three connectors can be installed at the rear of the instrument. If this feature has been included, the following additional connectors are added:

- 1) "BNC" INPUT connector.
- 2) Seven pin GAS TUBE connector.
- 3) Five pin DIODE connector.

Sect. II

These connectors are wired in parallel with the front panel terminals. Either set may be used singly.

F. AGC VOLTS

The tuned amplifier AGC voltage appears at these terminals. This voltage is useful in special applications such as noise figure measurements of a TWT amplifier, which require an indication of the TWT gain in relation to changes in noise figure.

The AGC voltage may also be used to indicate the power supplied to the 342A INPUT by the system under test. This is accomplished by correlating the AGC voltage to the input power using a source such as the Model 606 or 608 Signal Generator. With the generator set to CW, and tuned to 30, 60, 70, 105 or 200 mc, connect the output to the 342A INPUT connector. Measure the AGC voltage, as a function of the signal generator output (in dbm), with a voltmeter whose input impedance is 10 meg-ohms or greater, e. g. the P Model 410B or 412A VTVM. By using this information, the VTVM may now be used as a powermeter to monitor the over-all system under test. For utmost accuracy the 342A should be operated on a regulated power line in this application, as variations of the filament supply voltage will change the AGC/input power correlation.

2-3 RELATIVE NOISE FIGURE MEASUREMENTS

In most cases absolute values of noise figure are of academic interest only. What is really desired is to optimize the noise figure of a particular unit. For this application, the following procedures are sufficient.

2-4 WARM-UP

Before making preliminary adjustments or before measurements are made, the Model 342A should be allowed at least a five minute warm-up period to stabilize at a normal operating temperature.

2-5 METER MOVEMENT MECHANICAL ZERO

Whenever the meter pointer does not indicate exactly on zero, the pointer should be reset to zero. For most accurate positioning of the pointer, turn the instrument on for about 15 minutes to allow it to reach operating temperature. Turn off the power and wait at least 30 seconds for the capacitors in the instrument to discharge.

The adjust screw is at the meter frame at a mid-point immediately below the meter face. The adjustment is made properly only when the pointer is traveling in the opposite direction to the turn of the adjust screw. Although the adjust screw may be turned in either direction, a practical procedure is to turn the screw in a clockwise direction until the pointer starts to swing back toward zero. Then, still turning the screw clockwise, bring the pointer (now traveling counterclockwise), back to zero.

2-6 OPERATING PROCEDURES

The operating procedures are given pictorially in the following Figures:

- _2-2 Using a Waveguide Noise Source Setup to Measure Noise Figure
- _2-3 VHF Noise Source Setup to Measure Noise Figure
- _2-4 IF Noise Source Setup to Measure Noise Figure
- _2-5 Automatic Measurement of Noise Figure of a Microwave Receiver.
- _2-6 Automatic Measurement of Noise Figure of an Amplifier or VHF System
- _2-7 Manual Measurement of Noise Figure Using an 347A
- _2-8 Manual Measurement of Noise Figure Using an Diode Noise Source

Figures 2-2 through 2-4 are basic to the operation of the Noise Figure Meter. They contain instructions for connecting and using the noise sources and for setting the noise source current. The other figures supplement these basic setup procedures.

NOTE

A slight upscale reading on the meter is normal when the METER FUNCTION switch is set to either INF or NOISE FIGURE even though there is no signal connected to the INPUT. Meter current is produced by the thermal and shot noise in the amplifier circuitry.

USING A GAS TUBE NOISE SOURCE SETUP TO MEASURE NOISE FIGURES

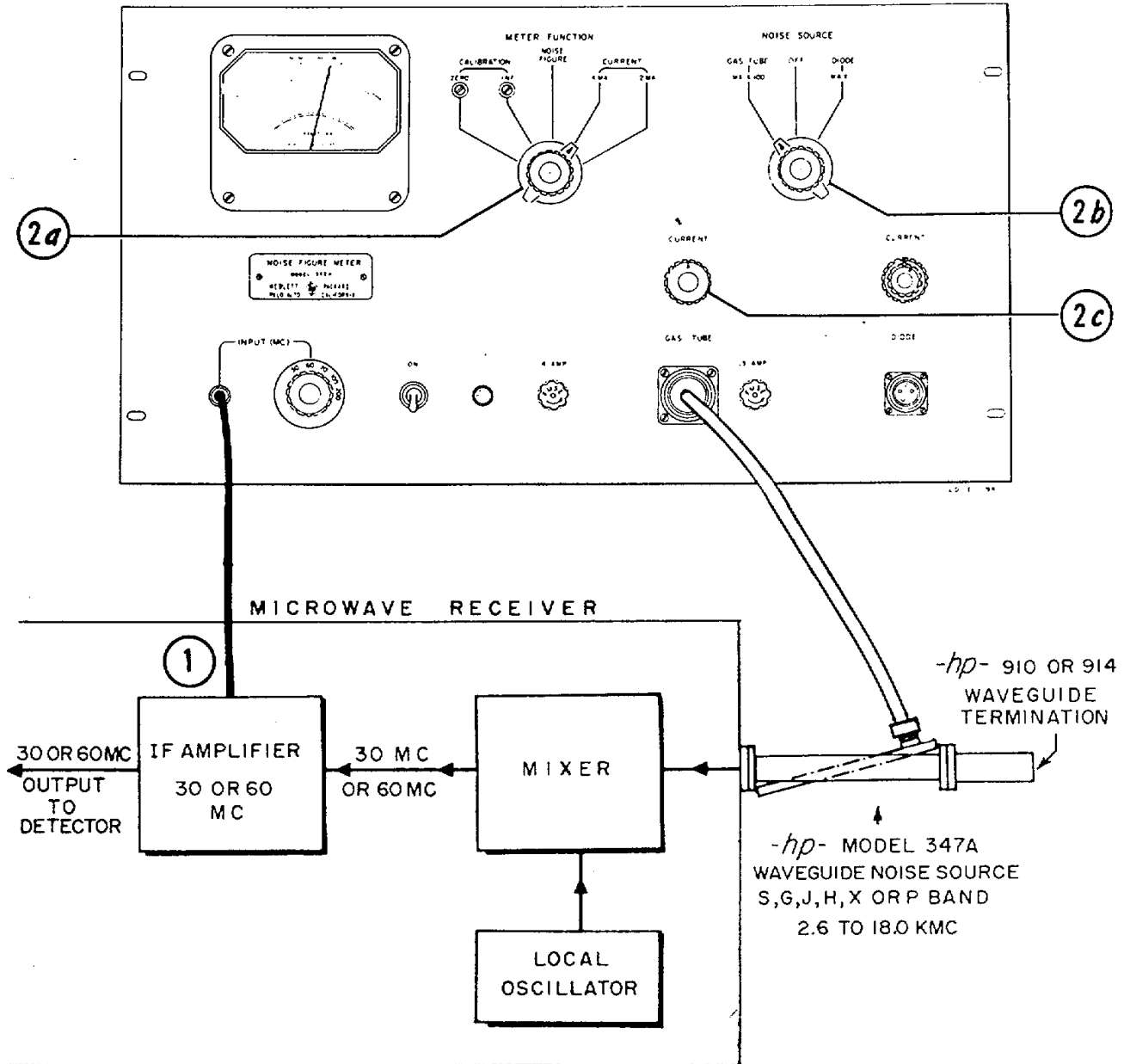

1. Connect to i-f amplifier where level (with noise source on) is between 60 and 10 dbm. Corresponds to 40 db minimum gain between hp 347A and 340B.
2. To adjust Gas Tube Current,
 - a) Set to appropriate current scale
 - b) Set to Gas Tube
 - c) Adjust current to value indicated in chart.

Model	Tube	Gas	Recommended Operating Current
S347A	1971-0002	Argon	250 ma
G347A	1971-0004	Argon	200 ma
J 347A	1971-0004	Argon	200 ma
H347A	1971-0011	Argon	175 ma
X347A	1971-0001	Argon	200 ma
P347A	1971-0003	Argon	175 ma
349A	1971-0011	Argon	150 ma

Figure 2-2.

VHF NOISE SOURCE SETUP TO MEASURE NOISE FIGURE

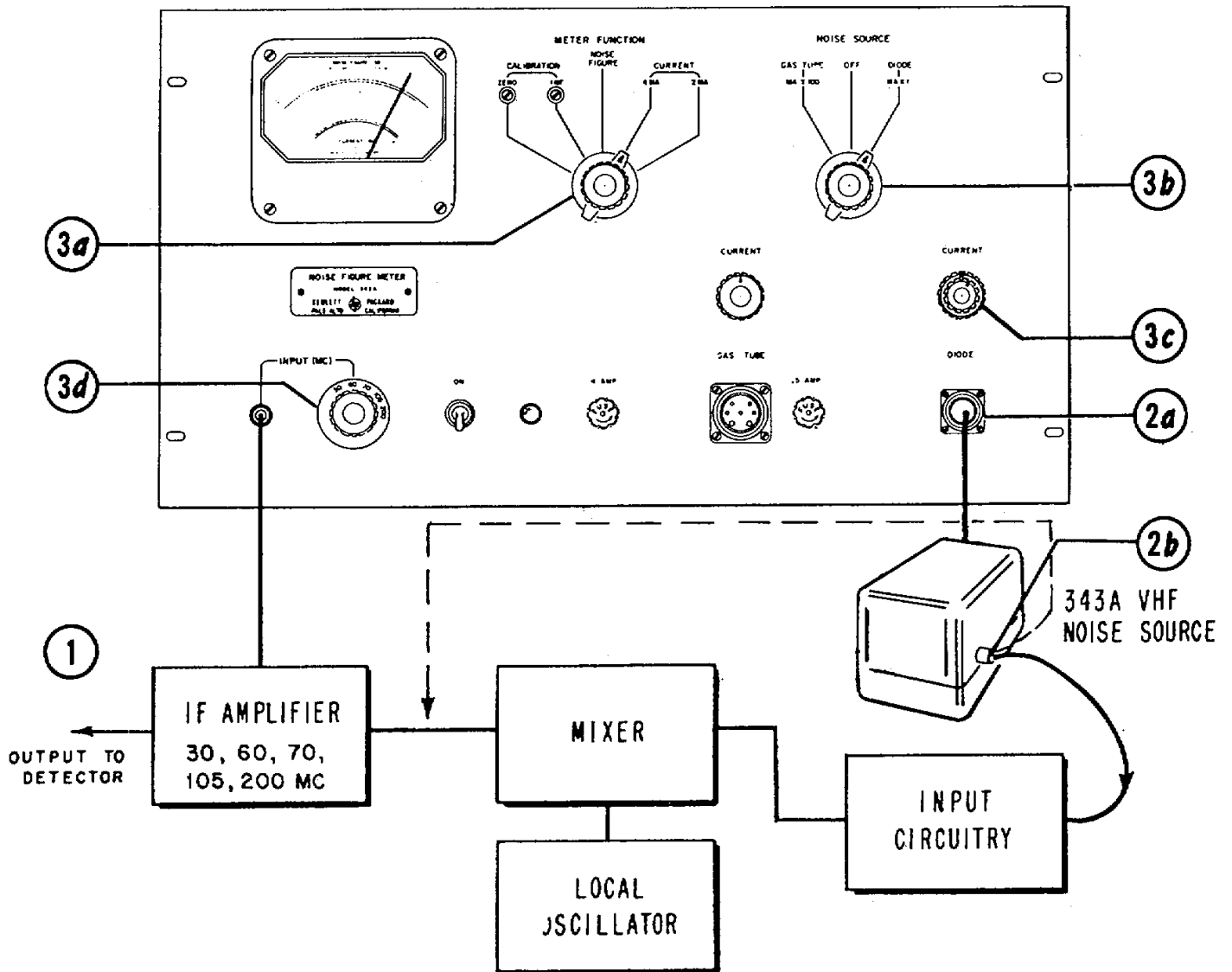

1. MODEL 342A
Connect to IF Amplifier where the level is between 60 and 10 dbm when the noise source is turned on. This corresponds to a minimum gain of 50 db between the 343A and the, 342A
2. MODEL 343A
 - a) Connect 343A to DIODE connector.
 - b) Connect output of 343A to measure over-all system or IF Amplifier noise figure

3. Set Model 342A controls.
 - a) Select current scale.
 - b) Set to DIODE.
 - c) Adjust to CURRENT** inculcated on 343A.
 - d) Set to frequency of IF Amplifier.

* Source impedance of 343A is 50 ohms and must be matched to IF Amplifier or system input impedance to avoid mismatch errors.

** If correct current value cannot be obtained, see paragraph 2-2D.

Figure 2-3.

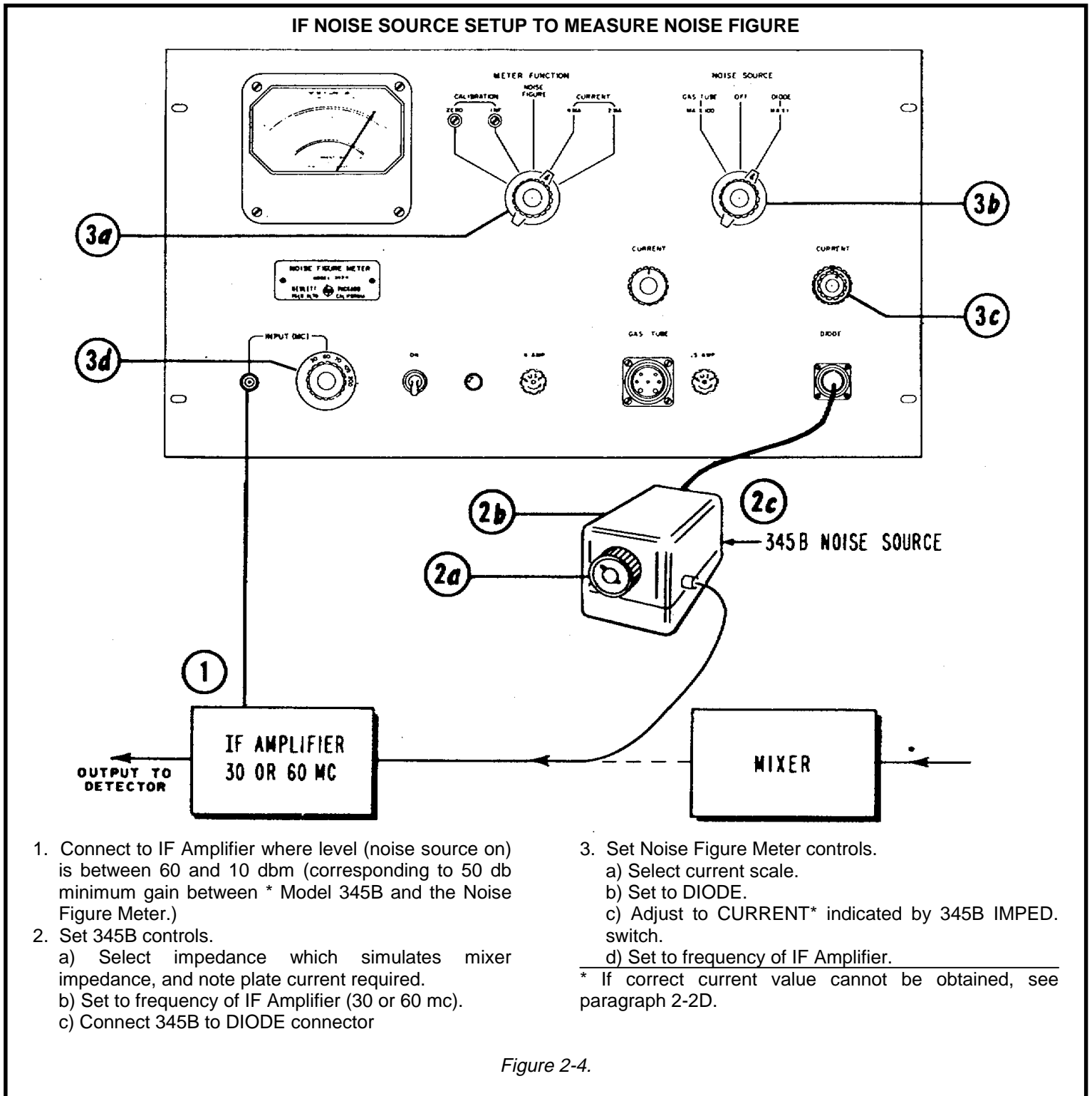

AUTOMATIC MEASUREMENT OF NOISE FIGURE OF A MICROWAVE RECEIVER

Make connections and adjust gas tube current as shown in Figure 2-2.

- (1) Set AUTO-MANUAL switch (on rear of Noise Figure Meter) to AUTO.

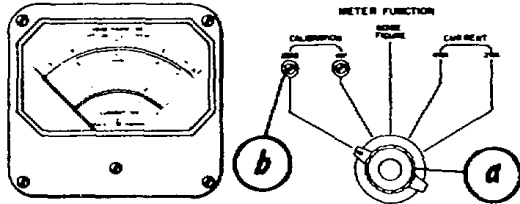

- (2) Adjust zero set.
a) Set to ZERO
b) Use screwdriver to set pointer to Zero.

- (3) Adjust infinity set

- a) Set to INF.
b) Use screwdriver to set pointer to INF.
Note - If pointer cannot be set to INF. More gain is required between the noise source and the input to the Noise Figure Meter.

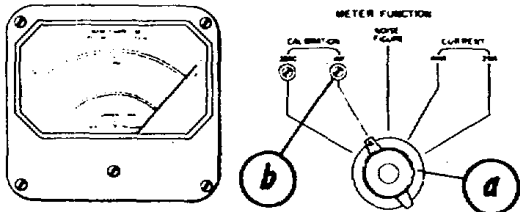

- (4) Measure Noise Figure.
a) Set to NOISE FIGURE and read noise figure on GAS TUBE scale of meter

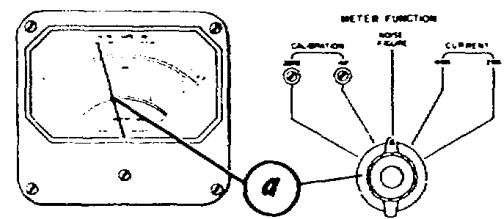
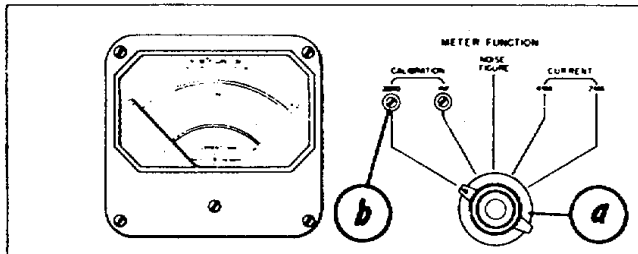

Figure 2-5.

AUTOMATIC MEASUREMENT OF NOISE FIGURE OF AN AMPLIFIER OR VHF SYSTEM

Connect equipment and adjust diode current as shown in Figures 2-3 and 2-4.

- (1) Set AUTO-MANUAL switch (on rear of the Noise Figure Meter) to AUTO.



- (2) Adjust zero set.
a) Set to ZERO.
b) Use screwdriver to set pointer to ZERO.

- (3) Adjust infinity set.
a) Set to INF.
b) Use screwdriver to set pointer to INF.
NOTE - If pointer cannot be set to INF, more gain is required between the noise source and the input of the Noise Figure Meter.

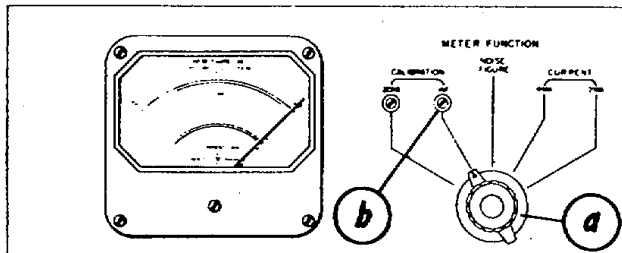

- (4) Measure Noise Figure.
a) Set to NOISE FIGURE and read noise figure on DIODE scale of meter.

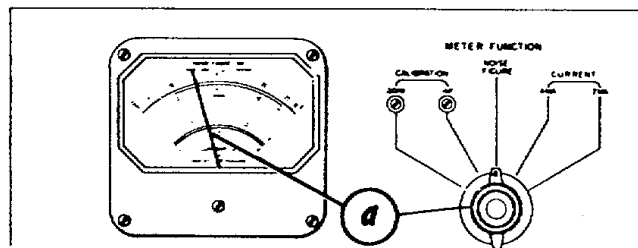
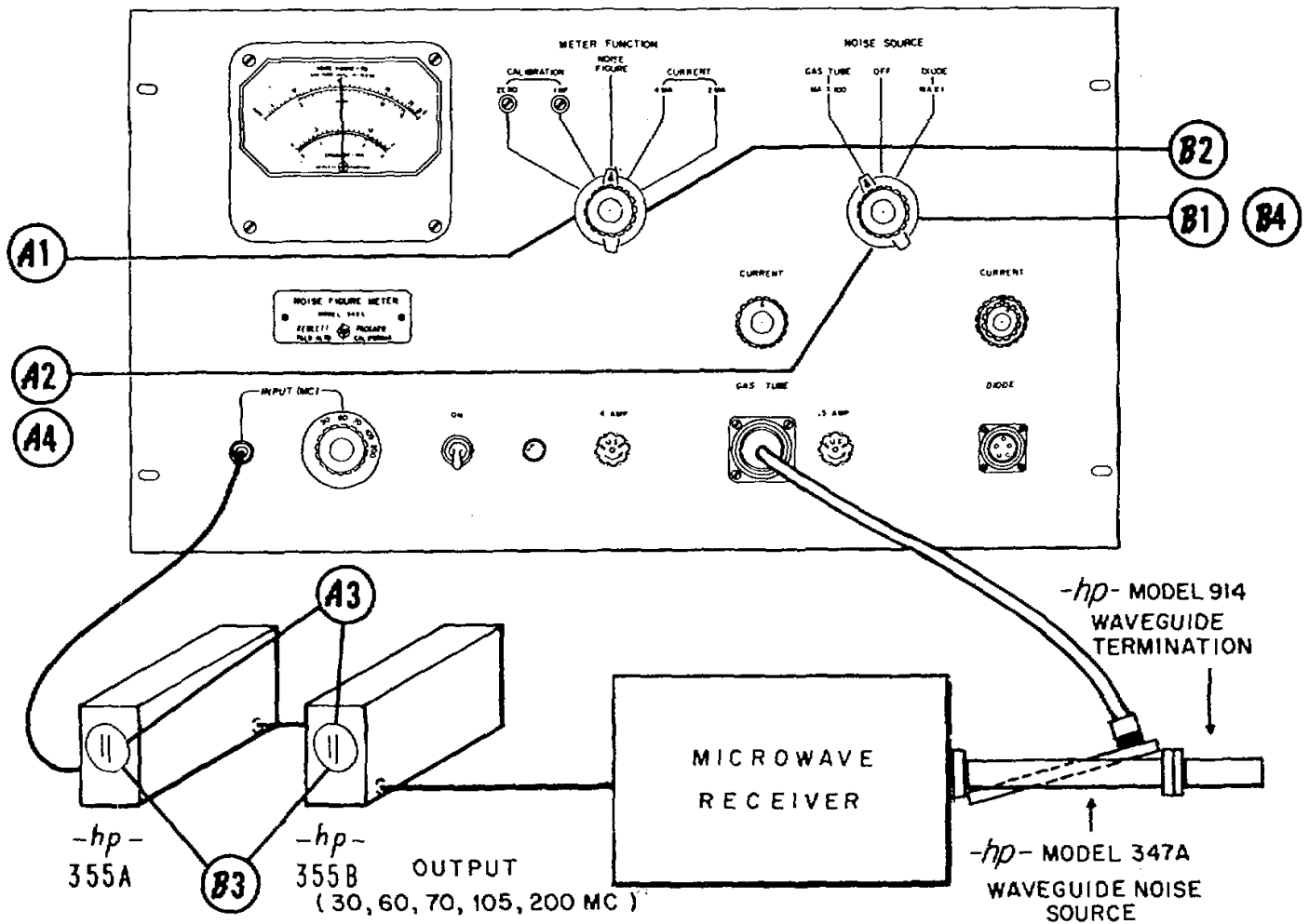

Figure 2-6.

MANUAL MEASUREMENT OF NOISE FIGURE USING AN  347A



1. Adjust noise source current as in Figure 2-2.
2. Set NOISE FIGURE switch (back of instrument) to MANUAL.

METHOD A

- A1 Set to NOISE FIGURE.
- A2 Set to GAS TUBE.
- A3 Set attenuator for a full scale meter reading.
- A4 Set to OFF.
- A5 Read noise figure from Gas Tube scale.

METHOD B

- B1 Set to OFF.
- B2 Set to NOISE FIGURE.
- B3 Set attenuator for convenient current scale reading > 1/4 scale (1 min.).
- B4 Set to GAS TUBE. Read current scale (I max.).
- B5 Calculate noise figure:

Figure 2-7.

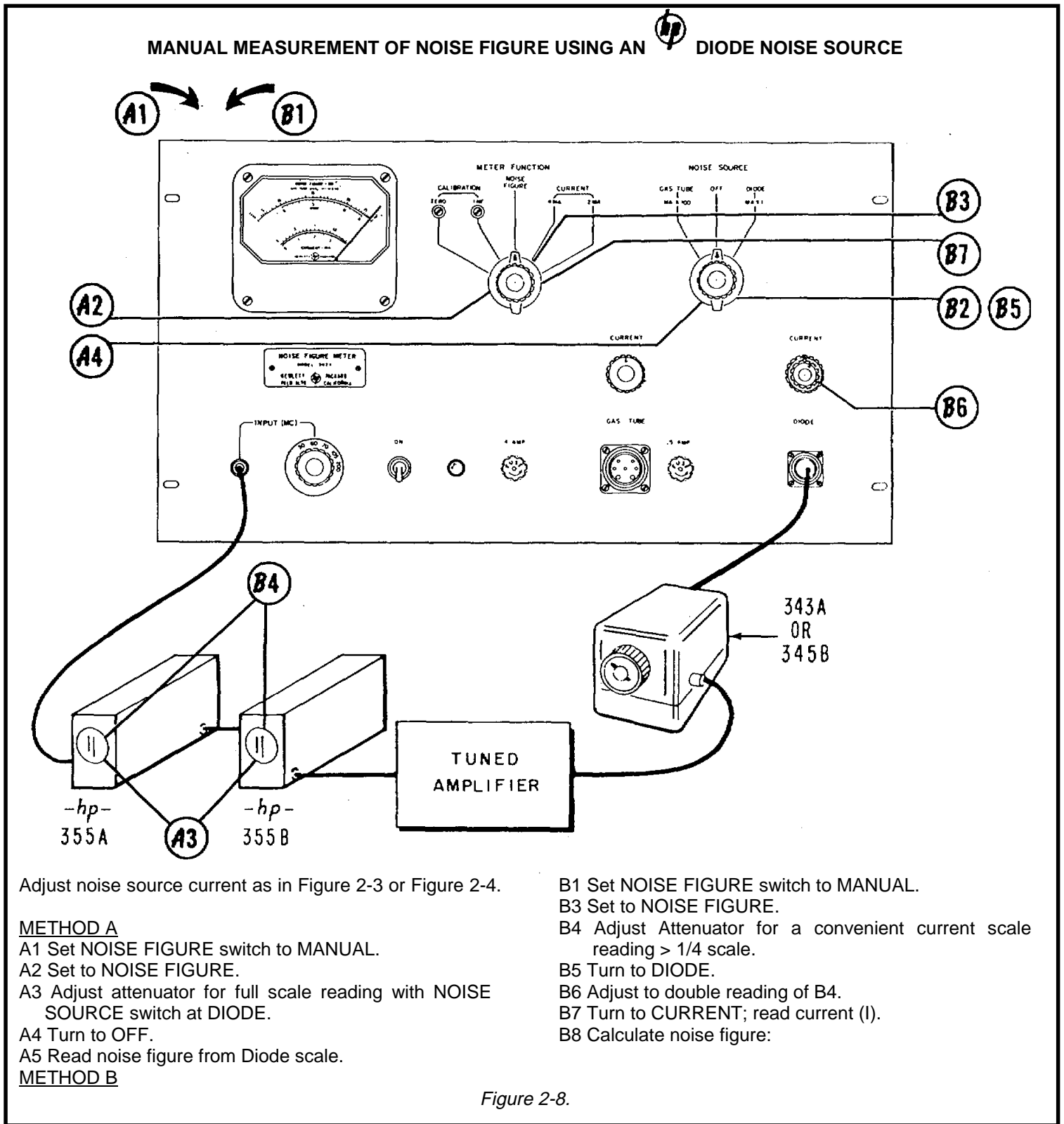

Figure 2-8.

2-7 USE OF AN EXTERNAL METER

The 342A Noise Figure Meter uses a 1 ma full scale dc meter to indicate noise figure and noise source current. For remote readout applications, an external meter may be connected to the RECORDER jack located at the rear of the instrument. A meter identical to that used in the instrument may be obtained from the factory. (See Section V for part stock number). For increased accuracy in reading low noise figures, a more sensitive meter may be connected in the same manner. An external meter may be calibrated in terms of noise figure (in db) by using Table 2-1.

The additional impedance created by adding an external meter may affect the calibration of the meter circuit. The INF CALIBRATION should be checked and reset if necessary (see Figure 2-5).

WARNING

The INF CALIBRATION control is adjusted to a value of 1 ma. This is the full scale current of the meter used if the 342A. If a more sensitive meter is used as discussed above, the meter should be replaced by its equivalent resistance. The INF CALIBRATION point should then be checked, and reset if necessary. Set the METER FUNCTION switch to NOISE FIGURE and then connect the meter. When using an external meter whose sensitivity is greater than 1 ma full scale, caution should be exercised. Under the following conditions the meter will be driven off scale:

- Turning off the noise source
- Setting the METER FUNCTION switch to INF CALIBRATION with external meter connected
- Measuring a noise figure which reads off scale

2-8 METER OFFSET

The METER FUNCTION switch circuitry of the 342A is arranged so that in NOISE FIGURE position the 342A can supply a negative bias current to an external meter or recorder (controlled by the ZERO calibration control). This offset current can be read on the internal meter in the ZERO set position of the METER FUNCTION switch because the polarity of the internal meter is reversed.

This feature essentially allows scale expansion for noise figure measurements, when using an external meter of greater sensitivity than the internal meter. This technique, however, does not increase the basic accuracy of the instrument. For optimizing adjustments this technique should prove useful. Assume that we are using an external meter whose sensitivity is 500 ja full

scale. As previously discussed, any noise figure over 5.0 db on the DIODE scale, or 15 db on the GAS TUBE scale, will drive the external meter movement off-scale. By using the offset feature, you can use the external meter to measure noise figures in excess of these limits.

TABLE 2-1. METER SCALE CURRENT

Gas Tube Noise Figure in db	Diode Noise Figure in db	Current in ma
Zero.....		0.0000
3.0.....		.0568
4.0.....		.0705
5.0.....		.0872
6.0.....		.107
7.0.....		.131
8.0.....		.160
9.0.....		.194
10.0.....	0	.232
10.5.....	0.5	.253
11.0.....	1.0	.276
11.5.....	1.5	.299
12.0.....	2.0	.324
12.5.....	2.5	.349
13.0.....	3.0	.376
13.5.....	3.5	.403
14.0.....	4.0	.431
14.5.....	4.5	.460
15.0.....	5.0	.489
15.5.....	5.5	.517
16.0.....	6.0	.546
16.5.....	6.5	.574
17.0.....	7.0	.602
17.5.....	7.5	.629
18.0.....	8.0	.656
18.5.....	8.5	.681
19.0.....	9.0	.706
19.5.....	9.5	.729
20.0.....	10.0	.751
21.0.....	11.0	.792
22.0.....	12.0	.828
23.0.....	13.0	.858
24.0.....	14.0	.884
25.0.....	15.0	.905
26.0.....		.923
27.0.....		.938
28.0.....		.950
29.0.....		.960
30.0.....		.968
INF.....		1.000

Consider the following example:

Assume that the noise figure reading of the 342A is 6.5 db, on the DIODE scale, and that the external meter is driven off-scale. Offset the 342A to 0 db (DIODE scale) or 10 db (GAS TUBE scale) by the following procedure:

1) With the input signal connected, and the Meter Function Switch set to ZERO, adjust the ZERO CALIBRATION control so that the 342A meter reads 0 db, or 10 db on the GAS TUBE scale.

2) Set the Meter Function switch to NOISE FIGURE and assume that the external meter reads 342.8 tea.

3) Add to this value the amount of offset current which may be determined by using Table 2-1. Zero db offset, n the DIODE scale, corresponds to a current o' 232 Ia. Therefore, the total current, which is a function of the noise figure of the system under test, is 574.8 gla. Using Table 2-1, this represents a noise figure of 6.51 db.

2-9 IMPROVING LOW NF MEASUREMENT ACCURACY

The accuracy of the 342A in measuring noise figures of 10 db or less in the microwave frequency bands is ± 1 db. This accuracy may be improved to $\pm 1/2$ db by the following technique. Reduce the excess noise level delivered to the device under test by the 347A Waveguide Noise Source. For example, the normal excess noise output is 15.2 db, and we reduce this by 10 db. The resultant excess noise applied to the device under test is 5.2 db. This is the same noise power which is delivered by the Diode Noise Sources (see paragraph 1-2). Since we are supplying 5.2 db of excess noise to the device under test, we can now read the noise figure directly on the DIODE Scale of the panel meter, The accuracy of the 342A when using the Noise Diode Scale is $\pm 1/2$ db. Figure 2-9 illustrates one particular method of reducing the excess noise to 5.2 db. An V Model 752C Directional Coupler, terminated with an 8 Model 914 Waveguide Termination, is inserted be-tween the Model 347A Waveguide Noise Source and the device under test.

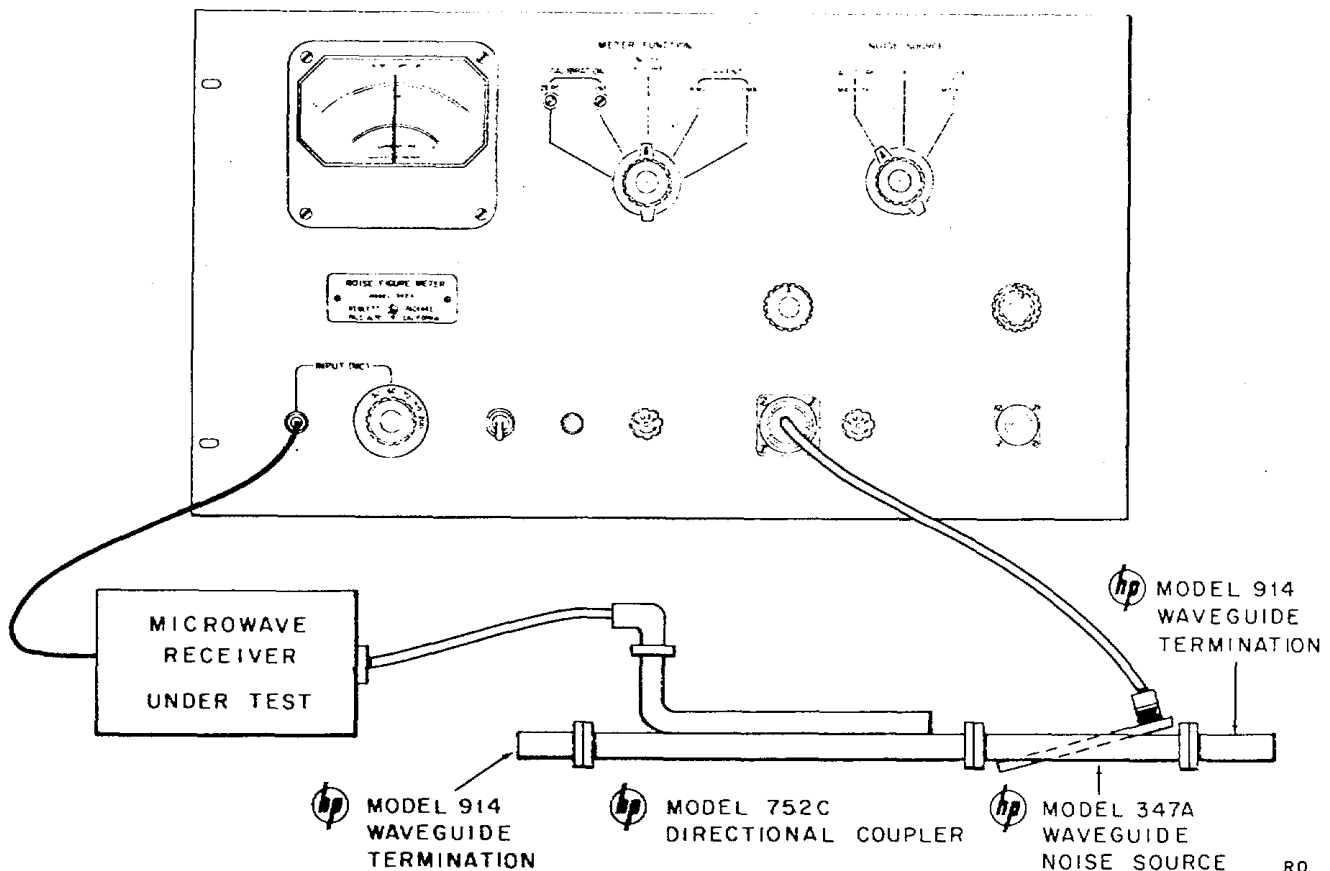

Figure 2-9. Improving Low NF Measurements

This same reduction of 10 db may be obtained by inserting an (Model 372C Precision Attenuator between the Source and load as shown in Figure 2-10. To obtain a 342A noise figure reading at a convenient point on the gas tube scale, the hobdel 382A Broad-band Precision Variable Attenuator may be used. The noise figure of the device under test would be equal to the meter reading minus the 382A attenuation setting.

The above techniques will increase the accuracy of the 342A Noise Figure Meter reading; however, the accuracy oa the attenuator or directional coupler which is used must also be considered. The accuracy of the Models 752C and 382A is dependent on the microwave receiver

frequency. A curve showing the individual attenuation characteristic is supplied with each device.

Model 342A

2-10 SOURCES OF ERROR

In some cases it may be necessary to know absolute values of noise figure. If so, consideration must be given to sources of error in the measurement. Noise figure is a relative measurement based on power available from a termination (input resistor) at a particular temperature 290° K. Several factors can cause a difference between measured and actual noise figure. Most important of these factors are:

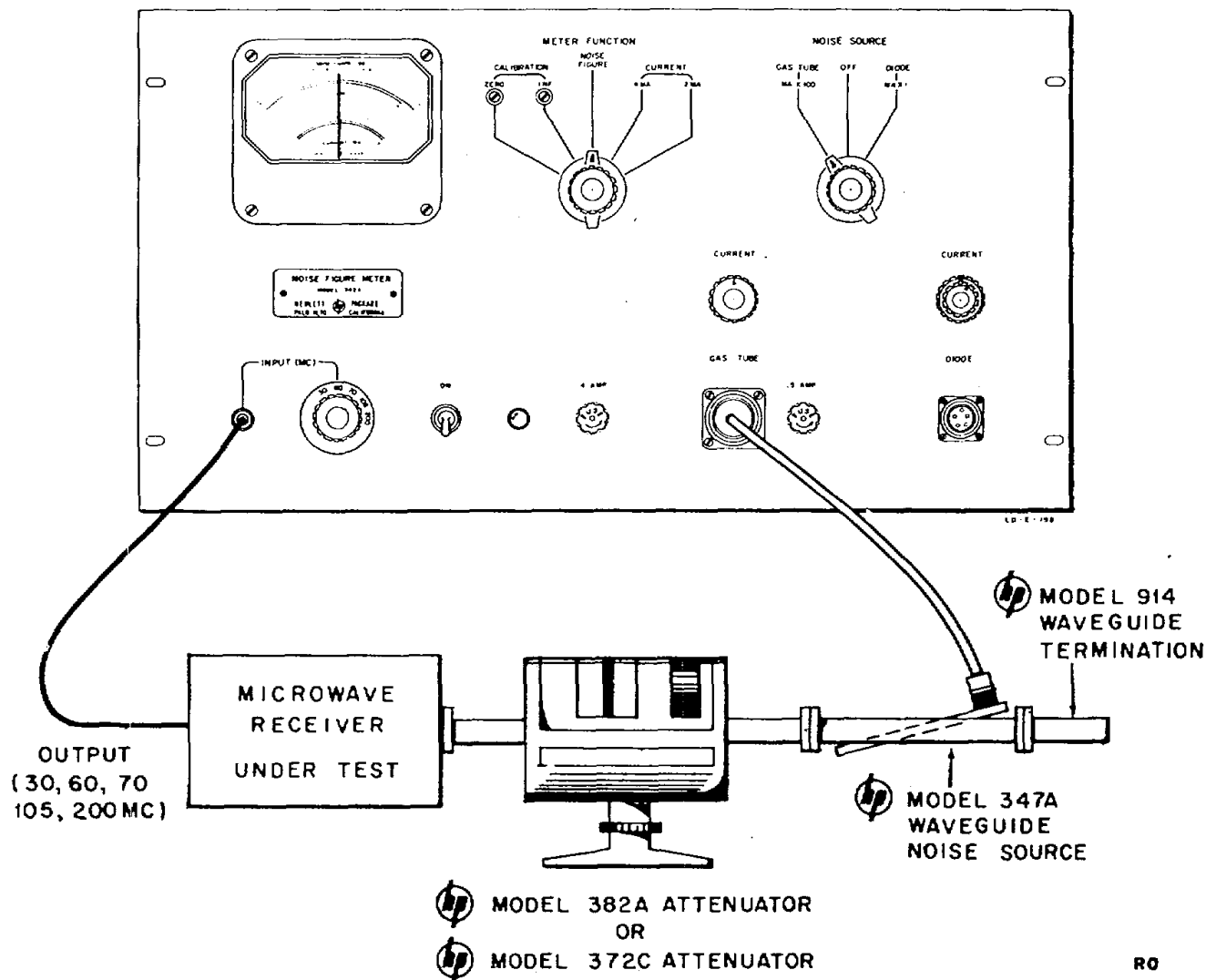

Figure 2-10. Improving Low NF Measurements

- 1) Coupling and transmission line errors.
- 2) Ambient or termination temperature different from 2900 K.
- 3) Receiver mismatch.
- 4) Noise source mismatch.

First of these sources of error is a function of the coupling of the noise power source to the transmission line and the attenuation of the line. These elements are called "hot loss" and "cold loss" respectively. "Hot loss" is equivalent to the attenuation (insertion loss) of the noise source when the source is turned on. "Cold loss" is the attenuation (insertion loss) when the noise source is off. Figure 2-11 is a plot showing corrections for measured noise figure as a function of hot and cold loss. When using an hp noise source, correction is unnecessary, since error is typically less than 1/4 db.

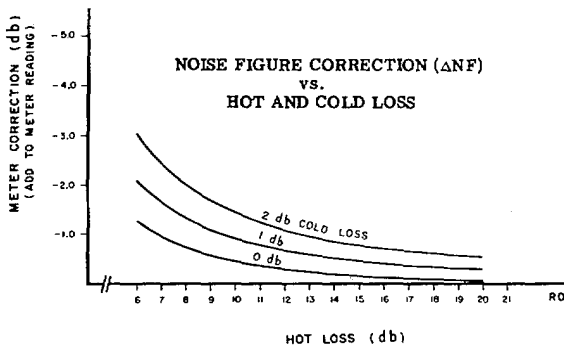

Figure 2-11. Hot-Cold Loss Correction

Figure 2-11 is calculated from the equation:

$$10 \text{ Log} \left[\frac{\alpha_s}{\alpha_c + \alpha_s} \right] \left[1 - 10^{-2(\alpha_c + \alpha_s)} \right]$$

where

$$\alpha_h = \alpha_c + \alpha_s = \text{hot loss constant}$$

$$\alpha_c = \text{cold loss constant}$$

Figures 2-12 and 2-13 are correction plots for temperature and are direct reading. The following equations express this relationship between actual noise figure and

the 342A noise figure reading for different ambient temperatures.

For Diode Noise Sources:

$$NF = 10 \text{ log} \left[\text{log}^{-1} \left(\frac{NF_M}{10} \right) - \left(\frac{T}{T_0} - 1 \right) \right]$$

For Gas Tube Sources:

$$NF = 10 \text{ log} \left[\text{log}^{-1} \left(\frac{NF_M}{10} \right) - \left(\frac{T}{T_0} - 1 \right) \left(1 + \text{log}^{-1} \frac{NF_M}{33.1} \right) \right]$$

Where:

- NF = actual noise figure
- NF_M = noise figure reading of the 342A
- T = ambient temperature in degrees K
- T₀ = reference temperature of 290 K

The equation for the gas tube source holds true if the source is looking into its waveguide load.

To use either of these two graphs:

--Locate the intersection of the 342A reading and the appropriate temperature line.

--Read the actual noise figure from vertical axis.

Mismatch errors are, in general, ambiguous errors and only the limits of the error can be specified since mismatch is a phase sensitive variable.

The mismatch error must be calculated for each system by considering that noise power follows all of the power transfer laws. A typical plot of the error limits for a receiver mismatch of 2:1 is shown in Figure 2-14. A similar family of curves can be derived for any receiver SWR. The actual error can fall anywhere between the limits indicated.

2-11 IMAGE CONSIDERATIONS IN RECEIVER NF MEASUREMENTS

When measuring the noise figure of a standard microwave receiver, a correction may be necessary to make the meter reading consistent with the accepted definition of receiver noise figure.

In a standard receiver the actual noise bandwidth consists of two IF bandwidths, one on each side of the local oscillator frequency. In general, only one of these sidebands is useful in signal amplification. The image contributes nothing but receiver and background noise.

$T_0 = 290^\circ\text{K}$ (17°C)

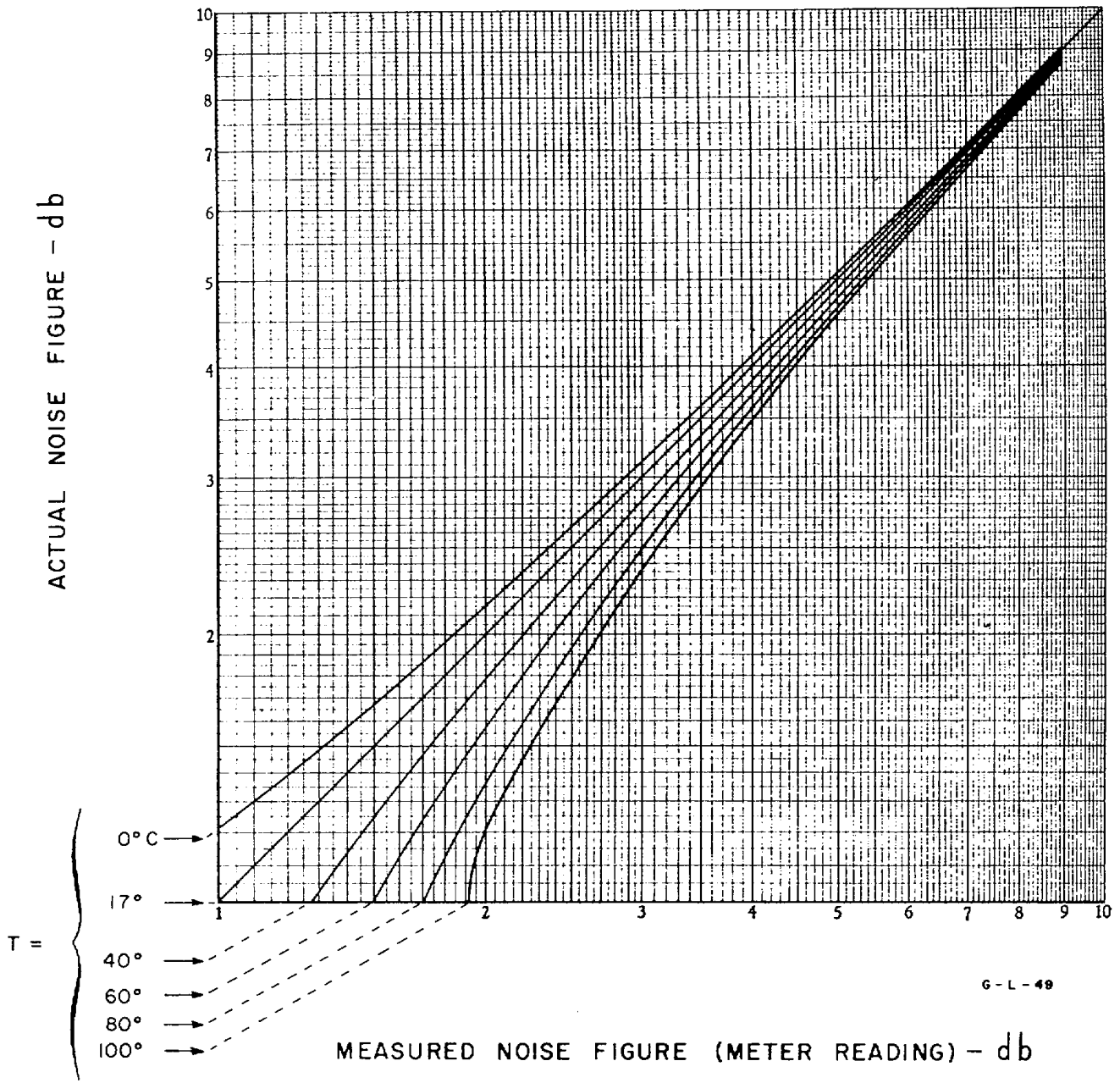
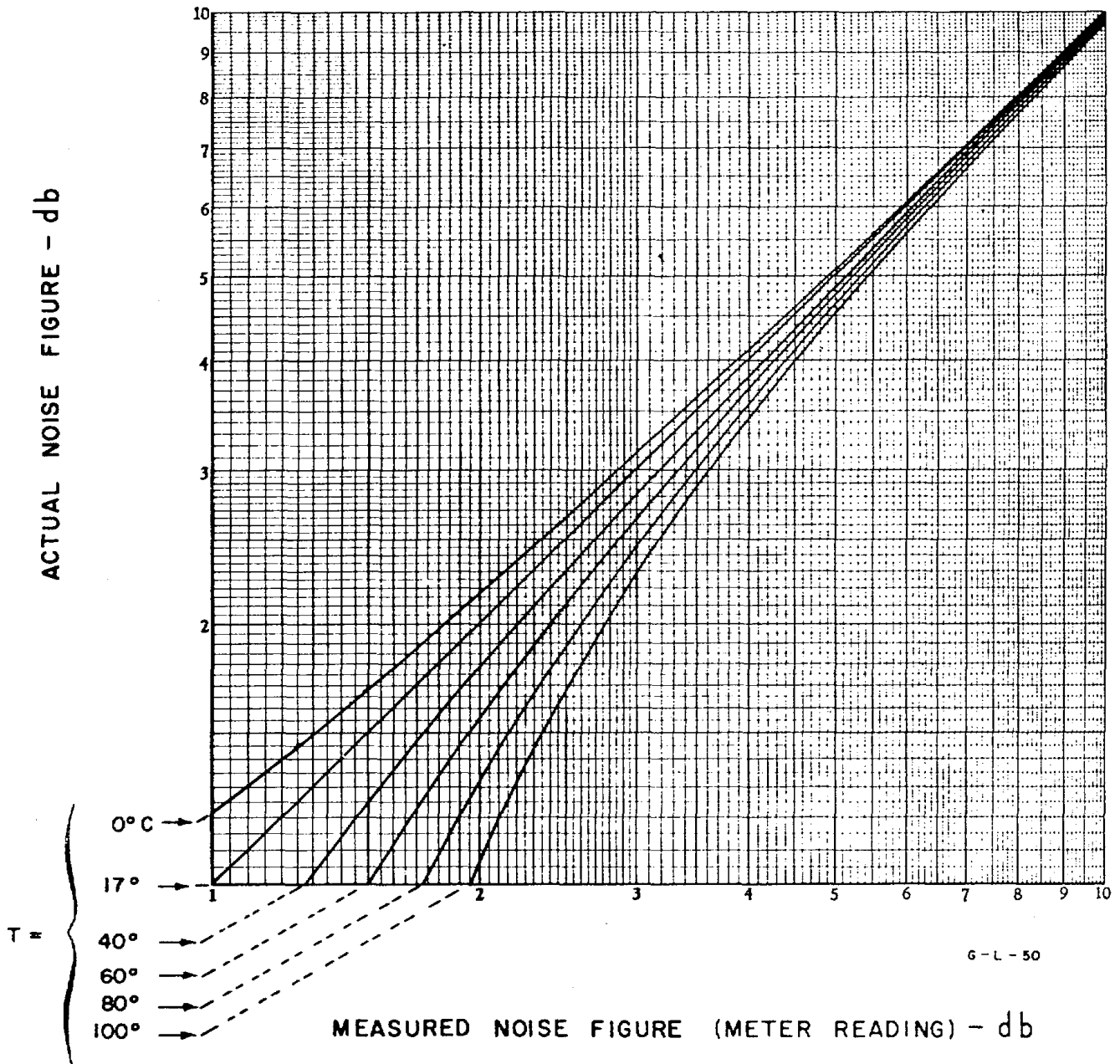

Figure 2-12. Temperature Correction for Model 343A VHF Noise Source and Model 345B IF Noise Source

$T_0 = 290^\circ\text{K} (17^\circ\text{C})$



G-L-50

Figure 2-13. Temperature Correction for Model 347A Waveguide Noise Source

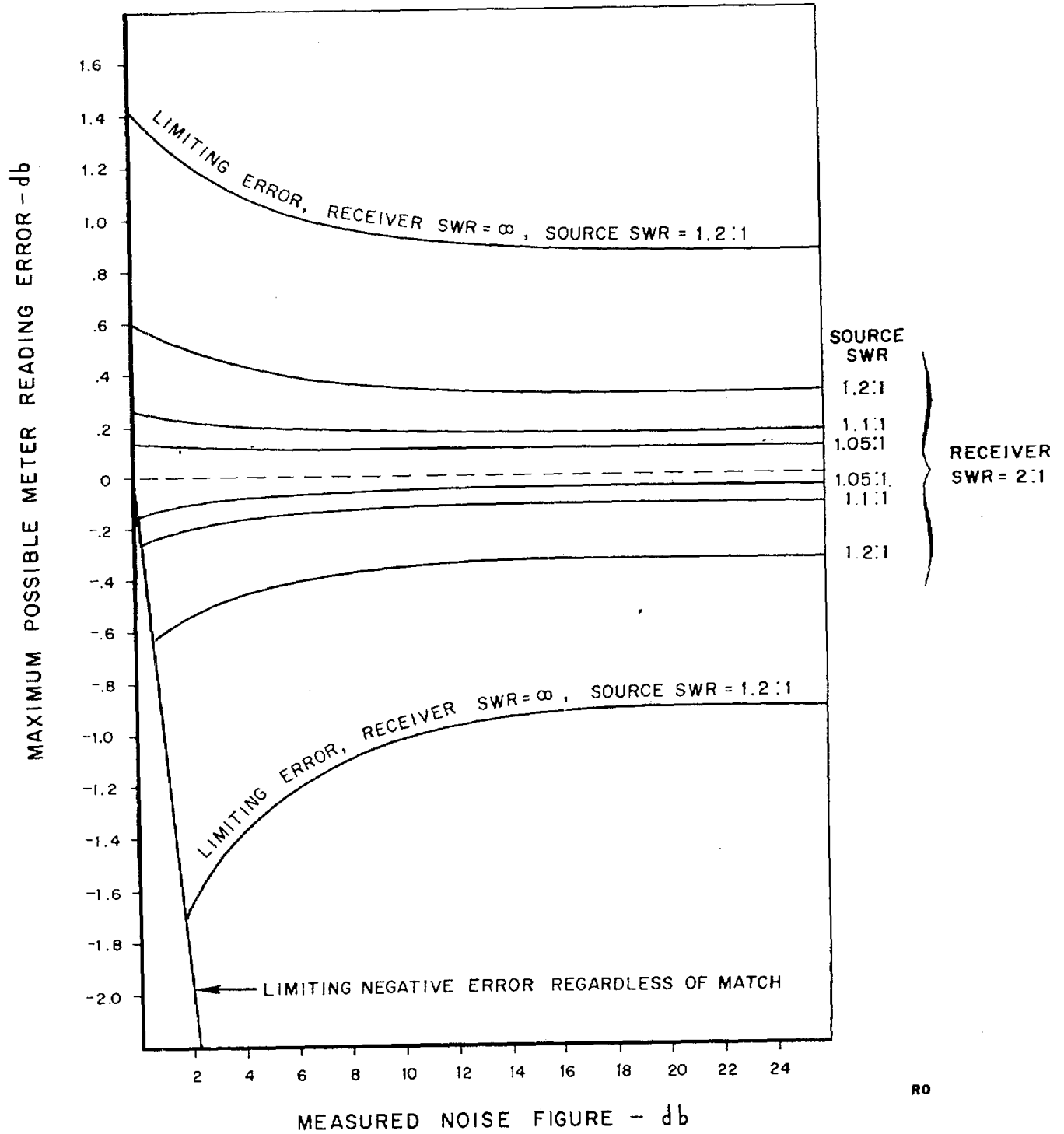

Figure 2-14. Mismatch-Error Limits

When a manual (twice power method) measurement is made using a signal generator, the signal appears in only one pass band. When making an automatic NF measurement, though, and using a wideband noise source such as the Model 347A or Model 343A, the excess noise is applied through both pass bands. Thus the instrument meter indicates the noise figure as based on both pass bands. However, the noise figure for receivers is generally specified with only one pass band for the useful signal. This means that the termination noise and the added noise in the receiver give a double contribution and thus the actual receiver noise figure is

poorer than that indicated. For equal image responses, which is a reasonable assumption, and in the absence of Figure 2-14 is calculated from the equation: preselectors or other image rejection elements, the Noise Figure Meter readings are 3 db lower than the actual noise figure for receiver measurements. This error may be easily compensated for by using a precision attenuator such as the Model 382A between the noise source and the input to the test system. The attenuator should be set so that its total insertion loss is 3 db. The 342A meter, then, may be read directly.

Figure 2-14 is calculated from the equation:

$$\left(\frac{N_2}{N_1} - 1\right)_{\text{MISMATCH}} = \frac{(F_S + 1) \left\{ \frac{|1 + P_g|^2 \times |1 - P_g|^2}{|1 - P_g P_n|^2 \times (1 - |P_g|^2)} \right\} \frac{|1 + P_f|^2 \times |1 - P_f|^2}{|1 - P_f P_n|^2 \times (1 - |P_f|^2)}}{\frac{|1 + P_f|^2 \times |1 - P_f|^2}{|1 - P_f P_n|^2 \times (1 - |P_f|^2)}} + NF - 1$$

$F_S - 1 =$ excess noise of noise source

$$F_S = \frac{T_2}{T_0}$$

NF = noise figure (ratio)

$P_g =$ noise source reflection coefficient in fired condition

$P_f =$ noise source reflection coefficient in unfired condition

$P_n =$ receiver reflection coefficient

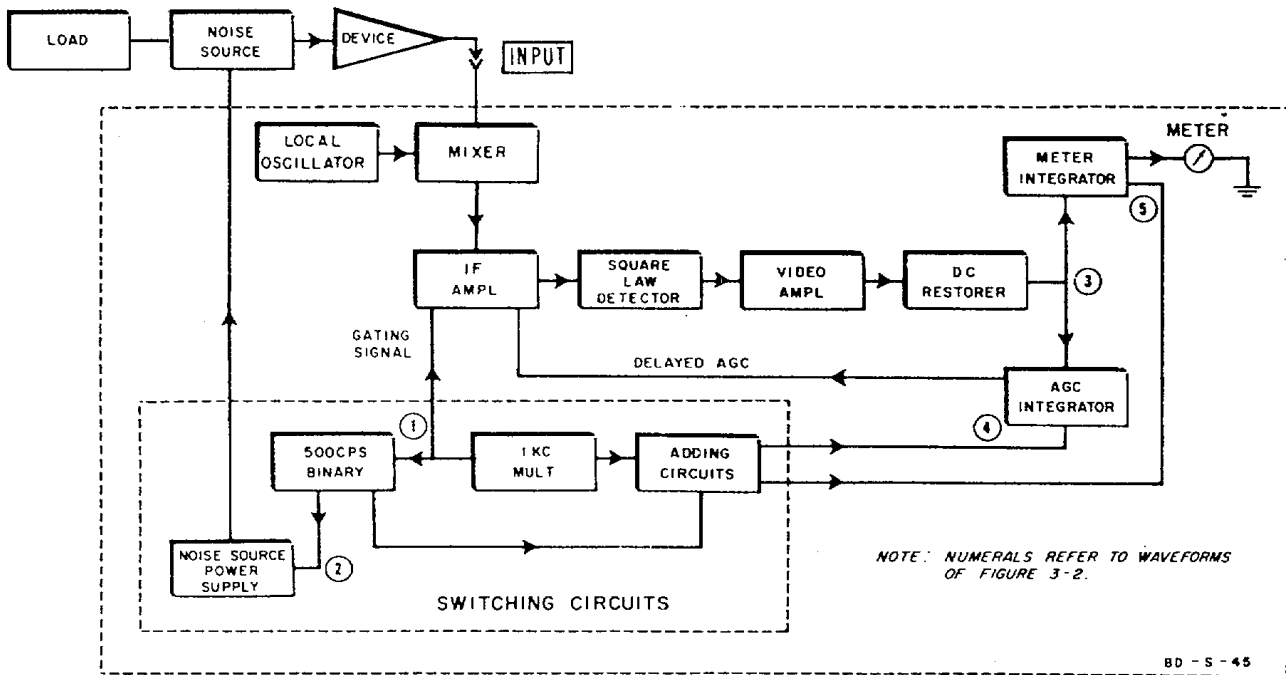

Figure 3-1. Model 342A Block Diagram

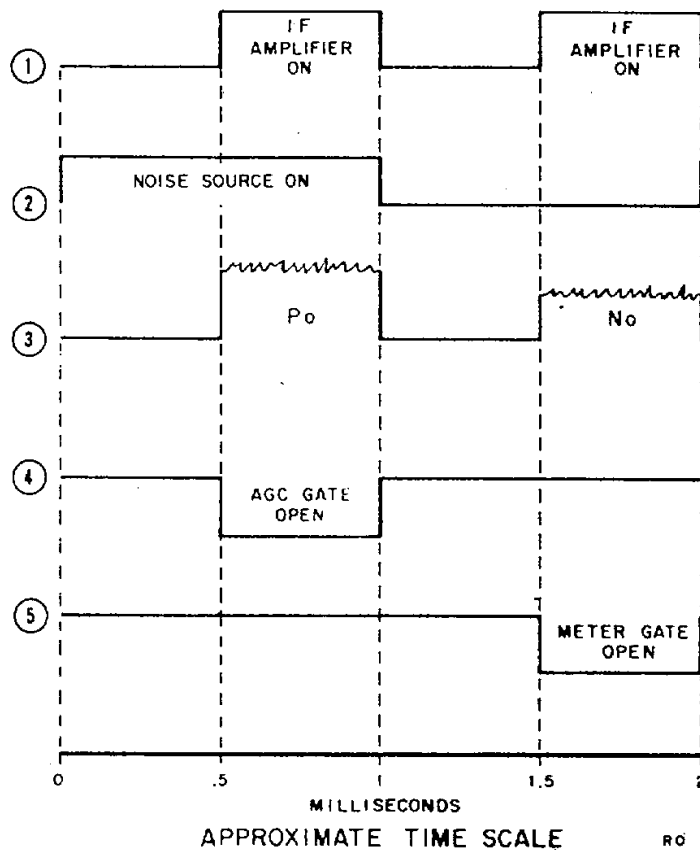

Figure 3-2. Waveform

SECTION III THEORY OF OPERATION

3-1 INTRODUCTION

This section contains a discussion and definition of noise figure and describes how the 342A accomplishes this measurement. The over-all circuit is described in terms of the complete block diagram shown in Figure 3-1. Each important circuit is discussed individually.

3-2 MEASUREMENT OF NOISE FIGURE

Noise figure is a measure of the reduction of a signal-to-noise ratio caused by the active network (receiver or amplifier) under consideration. If the network were noiseless, the signal-to-noise ratio would be unchanged by the network and the noise figure would be zero db. However, all electronic devices add noise to a signal as the signal passes through, reducing the signal-to-noise ratio. If the signal-to-noise ratio at the output of the device is half the signal-to-noise ratio at the input, noise figure is 3 db. A mathematical expression for noise figure is:

$$\begin{aligned} NF &= 10 \log \left(\frac{S_i/N_i}{S_o/N_o} \right) \\ &= 10 \log (S_i/N_i) - 10 \log (S_o/N_o) \end{aligned}$$

Where: **NF** = noise figure (db)

S_i/N_i = input signal-to-noise power ratio

S_o/N_o = output signal-to-noise power ratio

In actual practice, however, it is not possible to separate the signal from the noise at the output of a receiver and measure them separately because noise is always present. Since noise is always pre-sent, output of a receiver is P_o/N_o where P_o is $S_o + N_o$. P_o is the output of the device under test when the noise source is on. For the Models 343A VHF Noise Source and 345B IF Noise Source excess noise is 5.2 db. The gas-discharge type tubes used in the (Models 347A and 349A Noise Sources have been re-evaluated and with exception of the G347A and the J347A, have been found to provide values of excess noise other than as originally specified. Therefore, since the Noise Figure Meter is calibrated for

use with 3 gas-discharge type tube which produces 15.2 db excess noise, a correction factor must be applied to all meter readings other than those made with the G347A or the J347A (see Meter Corrections listings below for the specific correction factor necessary for your Noise Source).

<u>Noise Source Used</u>	<u>Meter Correction for Meter Readings</u> <u>Correction Factor</u>
349A	+0.5 db (1000-4000 Mc) +0.4 db (500-1000 Mc)
S347A	-0.1 db
H347A	+0.5 db
X347A	+0.7 db
P347A	+0.8 db

For example: Assume a reading of 16.0 db using the Model H347A with the Noise Figure Meter. The correction factor given for the H347A is +0.5 db; hence, the corrected reading is 16.0 db + 0.5 db or 16.5 db. Model 342A measures noise figure by comparing the output of the device under test when the noise source is on (P_o), to the output of the de-vice when the noise source is off (N_o). The comparison is made by keeping P_o constant with automatic gain control (AGC) and metering N_o .

3-3 OVER-ALL OPERATION

Operation of Model 342A Noise Figure Meter is described with reference to Figure 3-1, the complete block diagram (except for the power supply) and the waveforms in Figure 3-2. The Switching Circuits, consisting of the 1000 cps Multivibrator, the 500 cps Binary, and the Adding Circuits, supply the gating signals to the rest of the 342A. The Block diagram and waveforms are shown for automatic measurement of noise figure. The multivibrator gates the IF Amplifier with a 1000 cps square-wave voltage and drives the Binary which produces a 500 cps square wave. Output from the Binary drives the Noise Source Power Supply which turns the noise source on and off at 500 cps. Waveforms 1 and 2 show that the IF Amplifier is gated on during the last half of the time that the

Sect. II

noise source is on and also during the last half of the time that the noise source is off. Thus, the IF Amplifier is not turned on until the output from the noise source has reached its maximum level or fallen to its quiescent level. The output of the noise source is connected to the receiver being measured. The intermediate frequency of this receiver is connected to the INPUT of the 342A. This signal is the output of the receiver under two conditions: 1) noise source on, 2) noise source off. The RF and IF Amplifiers amplify this signal which is detected by the detector. This detector is operated over the square-law portion of its characteristic, therefore its output volt-age is directly proportional to input power. Further amplification takes place in the Video Amplifier and then the zero signal level (which occurs when the IF Amplifier is off) is clamped by the DC Restorer. The clamped signal is shown in Figure 3-2, wave-form 3. The larger amplitude pulse is the output of the Video Amplifier when both the noise source and the IF Amplifier are on; this output corresponds to Po. The smaller amplitude pulse is the Video Amplifier output when the noise source is off and the IF Amplifier is on. The small output signal corresponds to No.

During the time that Po is present at the output of the Video Amplifier the gate to the AGC Integrator is open (waveform 4) and the signal Po is passed through the ACC Integrator. After Po is integrated and filtered, it controls the gain of the RF and IF Amplifiers to keep subsequent Po pulses at a constant amplitude.

During the time that No is present at the output of the Video Amplifier, the Meter Integrator Gate is open (waveform 5) and No is passed to the Meter Integrator and, after integration, to the meter. Since the Si to Ni of the noise source is a known constant, and since Po is held constant by the AGC, the meter may be calibrated directly in db of noise figure.

The waveforms which operate the AGC and Meter Gates are developed in the adding circuits by ad-ding the 1000 cps square-wave voltage from the multivibrator to the 500 cps square-wave voltages from the Binary and clipping the resultant wave-forms at the appropriate voltage.

3-4 RF AMPLIFIER, MIXER AND LOCAL OSCILLATOR

The output signal from the device under test is connected to the INPUT of the RF Amplifier, V6, which is a cascade amplifier stage. The voltage divider R21 and R23 matches the AGC characteristics of the RF (6922) and IF (6AU6) Amplifiers. The Local Oscillator, V7B, is a

modified Colpitts type, and is capacitively coupled to the Mixer, V7A. Since the grid of the oscillator is at ac ground, the coils L11 L14 have one end connected directly to ground. This arrangement reduces the stray capacitance, thereby increasing the stability and reliability of the oscillator. For input frequencies of 60, 70, 105 and 200 mc, the oscillator is tuned to 90, 100, 75 and 170 mc respectively. When the input signal is 30 mc, R30 is switched into the circuit to disable the oscillator. The 30 mc signal is then passed through the Mixer to the IF Amplifier. Since the RF Amplifier-Mixer interstage is not tuned for a 30 mc rf input, sensitivity at 30 mc and higher frequencies is approximately the same.

3-5 IF AMPLIFIER, DETECTOR, VIDEO AMPLIFIER AND DC RESTORER

The IF Amplifier, Detector, and Video Amplifier are shown in schematic diagram, Figure 4-4; the DC Restorer is shown in Figure 4-5. The 30 mc signal from the Mixer is connected to the IF Amplifier, amplified and passed to the Detector and Video Amplifier. The IF Amplifier is gated on and off at a 1000 cps rate by a square-wave voltage connected to the suppressor grid of V8. Turning the IF Amplifier on and off established a zero signal level and permits measuring Po and No. Since the Detector is square law, its output voltage is a direct function of input power. If the IF Amplifier were not turned off, the output from the Video Amplifier would be a square-wave voltage whose amplitude increased as noise figure decreased. IF Amplifier, Detector, and Video Amplifier are conventional, except that the IF Amplifier is gated. Following the Video Amplifier is DC Restorer, V102B, which allows the recovery of the dc value of the noise pulses even though the signal is ac coupled. V102B, shown on the Meter and Gate Circuits schematic of Figure 4-5, clamps the zero signal level (IF Amplifier off) to 150 volts.

3-6 SWITCHING CIRCUITS

The switching circuits consist of the 1000 cps Multi-vibrator, V104, the 500 cps Binary, V106, the Ad-ding Clamp, V105. These circuits operate the Noise Source Power Supply, turn the IF Amplifier on and off, and separate the "source on" output from the "source off" output by opening the Meter and AGC Gates at the appropriate times.

Multivibrator, V104, free runs at a nominal rate of 1000 cps, however, the rate is adjustable over a narrow range. The rate in no way affects accuracy of the Model 342A.

Multivibrator V104 drives V106, which produces a square-wave voltage at exactly one-half the frequency of the Multivibrator. The 1000 cps square wave from V104 is added through resistance dividers to both phases of the 500 cps square-wave voltage from V106 and clipped by V105A and B to form the Integrator Gate signals.

The negative steps of the gate signals open the integrators and allow the signals from the Video Amplifier to be separated. A signal is also taken from the 1000 cps multivibrator to gate the IF Amplifier, and other signals from the 500 cps Binary operate the Noise Source Power Supply.

3-7 NOISE SOURCE POWER SUPPLY

This power supply furnishes the voltage required by the Hewlett-Packard noise sources and controls the current through them. In addition, the power supply turns the noise source on and off at the correct times. Since the power requirements of wave-guide noise sources (using an argon gas tube) are so different from the requirements of the temperature-limited diode type, the power supply is divided into two sections.

GAS TUBE SECTION

This supply furnishes the high ignition voltage required by the gas tube of the noise source and also controls the current passing through it.

The Gas Tube Pulse, V108, and V109, the Gas Tube Igniter, as shown in the schematic diagram, Figure 4-5, are driven by opposite phases of the 500 cycle square-wave signal from the Binary so that only one tube conducts at a time. When V108 is cut off by the signal from the Binary, the gas tube is off and the plate current from V109 goes through L101. When V108 is turned on, V109 is turned off, and L101 develops a large pulse which ignites the gas tube. Once the gas tube is ignited, the self bias of V108, set by R154 (CURRENT control) determines the gas tube current. Possibility of shock from the high voltage ignition pulse is materially reduced because the B+ connection to the supply is made through the 347A Waveguide Noise Source. Hence, the high voltage supply cannot operate unless a 347A Noise Source is connected to the instrument.

DIODE SECTION

The diode section consists of a multivibrator V110 and V111, which supplies regulated filament voltage for the diode of the noise source and a pulser to turn the noise source on and off. Output voltage of the multivibrator is controlled by varying the plate voltage of the tubes with the CURRENT control, R121. V107, the Diode Pulse is an amplifier which biases the noise diode off by driving the filament-cathode of the diode to a high positive

voltage. Setting the NOISE SOURCE switch to DIODE connects the Diode Pulser to the output jack J103.

3-8 AGC GATE AND INTEGRATOR

The AGC Gate V103A and Integrator V101A are shown in the schematic diagram, Figure 4-5. R106 is common to both cathode circuits and the voltage drop across it biases V101A well into cut-off as long as V103A conducts. When both the IF Amplifier and noise source are on, the gate signal from the Switching Circuits biases V103A into cut-off permitting conduction through V101A. Since the video signal connected to V101A is clamped by the DC Restorer to 150 volts, the average current through V101A depends on the amplitude of the signal at the input of the 342A. The negative voltage developed at the plate of V101A is thoroughly filtered and returned to the first two stages of the IF Amplifier and to the RF Amplifier, V6. In this way the gain of the RF and IF Amplifier is controlled to keep its output constant when the noise source is on (PO), so that the amplitude of No is a function of noise figure.

R103 (the INF control) in the plate circuit of V101A is a fine adjustment on the AGC voltage. This control calibrates full scale for any particular set of input conditions. Setting the METER FUNCTION switch to INF turns the noise source on each time the IF Amplifier is gated on, thus, the pulses which go to the Meter Integrator are the same amplitude as those which go to the AGC Integrator. This condition corresponds to $No = Po$, or a noise figure of infinity. Then R103 is adjusted for a noise figure meter reading of infinity when the METER FUNCTION switch is set to INF.

3-9 METER GATE AND INTEGRATOR

As can be seen from the schematic diagram, Figure 4-5, this circuit differs only slightly from the AGC Gate and Integrator. Except for the timing, the operation of the two circuits is the same. The gate signal from the Switching Circuits cuts off V103B, allowing V101B to conduct only when the Tuned Amplifier is on and the noise source is off. Since the signal applied to the grid of V101B is the clamped video signal from the DC Restorer, the average current through V101B increases as the pulse, No , gated through the Meter Integrator, increases in amplitude. This current is read on the meter which is calibrated in noise figure.

Setting the METER FUNCTION switch to ZERO supplies a zero noise condition to the grid of the Meter Integrator. Then R109 (the ZERO control) may be adjusted to bring the plate voltage of V101B to ground so there is no current through the meter.

Sect. II

3-10 MANUAL OPERATION

In manual operation the opposite phase from the Binary drives the Noise Source Power Supply so that the noise source is turned on one-half millisecond before the meter integrator is turned on. Also, the AGC voltage is grounded so that the full gain of the Gated Amplifier is present. Because of the square-law detector, meter deflection is proportional to input power. Thus, the 342A

becomes a sensitive detector which is accurately square law over the upper three-fourths of the meter scale. Relative power measurements made below one-fourth scale will have reduced accuracy because the low signal level prevents the DC Restorer from clamping effectively. This does not occur during automatic measurements because alternate pulses are large in amplitude and the DC Restorer clamps effectively.

SECTION IV MAINTENANCE

When connection for 230 volt operation is made, change the line fuse to a 2 ampere slow-blow type.

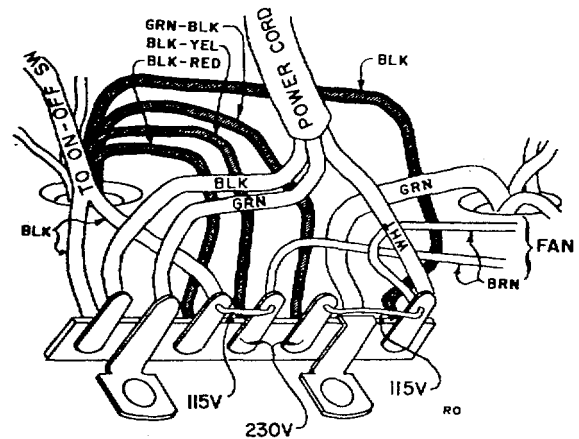

Figure 4-1. Transformer Connection

4-1. CABINET REMOVAL

- 1) Remove the four screws holding the rear cover and remove the cover.
- 2) Place the 342A on its back
- 3) Unscrew the two recessed screws about 1/4". These are located under the front panel
- 4) Remove the cabinet by lifting it toward the top of the instrument

4-2. CONNECTION FOR 230 VOLT OPERATION

To connect this instrument for 230 volt operation, remove the two wire jumpers from the terminal strip to which the power cord is attached. Install a new jumper to connect the green-black wire to the black-yellow wire.

4-3. OVER-ALL PERFORMANCE CHECK

The following check can be easily made with the instrument in its cabinet and will verify that the complete instrument is working normally and is accurately calibrated. Over-all operation is checked by comparing an automatic measurement with a "twice power" measurement.

In a 'twice power' measurement, the 342A is used only as a sensitive power monitor which can cause no error since power into it is kept constant. Figures 4-2 and 4-3 give the procedures for this performance check.

Figure 4-2 indicates that a 60 mc IF Amplifier is used. Actually any IF frequency can be used which will correspond with one of the 342A INPUT (MC) frequencies. It is not advisable to make this performance test at 30 mc as the mixer stage will not be checked.

PERFORMANCE CHECK USING  DIODE NOISE SOURCE

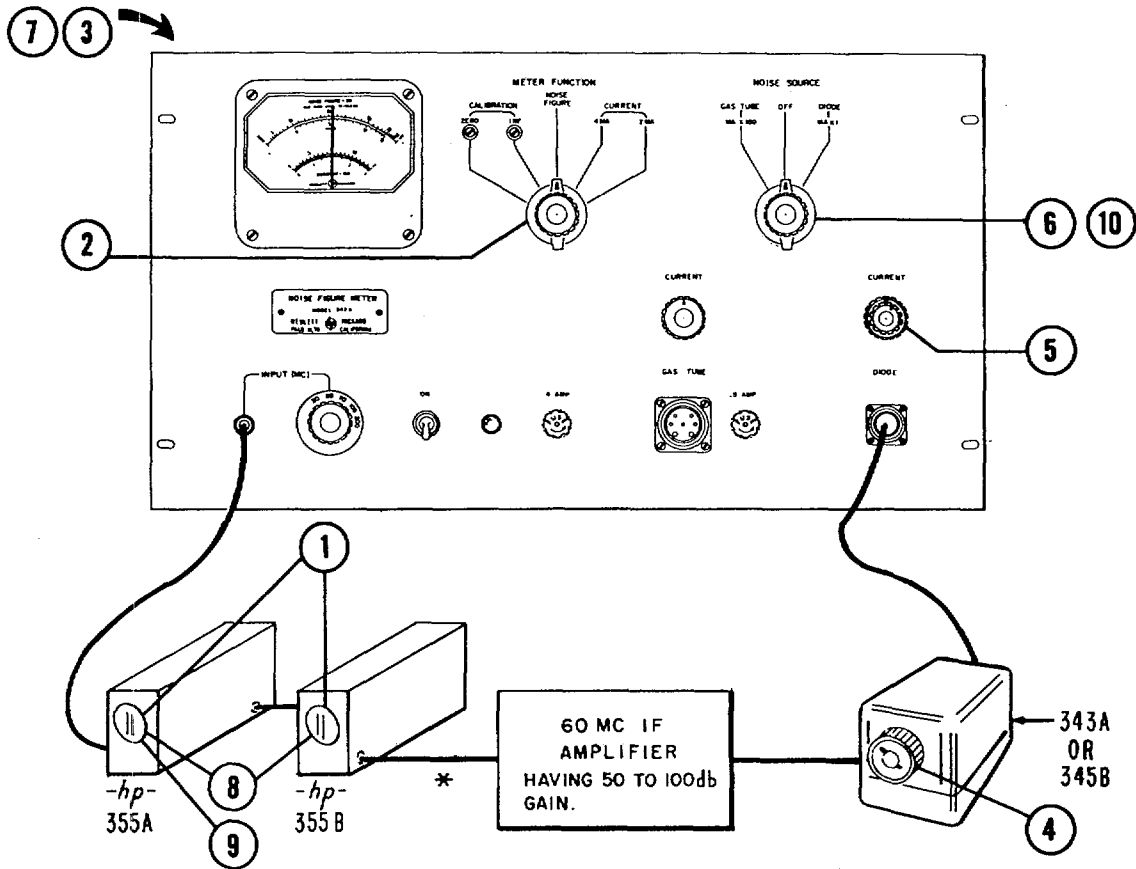

1. Connect equipment as shown above, set both attenuators to zero, and set the INPUT switch and 345B switch to IF amplifier frequency.
2. Adjust zero, inf. then set to NOISE FIGURE.
3. Set NOISE FIGURE switch (back of instrument) to AUTO.
4. Set to 50 (when using the  345B).
5. Set for 7.5 db on the meter diode scale.
6. Turn to OFF.
7. Set NOISE FIGURE switch to MANUAL.
8. Adjust attenuator for a reference reading near mid-scale on the lower current scale. This reading is I_1 .
9. Add 2 db.*
10. Turn to DIODE. Read I_2 on lower current scale. It should equal I_1 .
11. If $\frac{I_1 - I_2}{I_1}$ is ± 0.05 or less, the 342 is operating within specifications.

* Correct for impedance mismatch if IF Amplifier output is other than 50 ohms and the 355B is set for less than 20 db.

Figure 4-2.

PERFORMANCE CHECK USING  347A WAVEGUIDE NOISE SOURCE

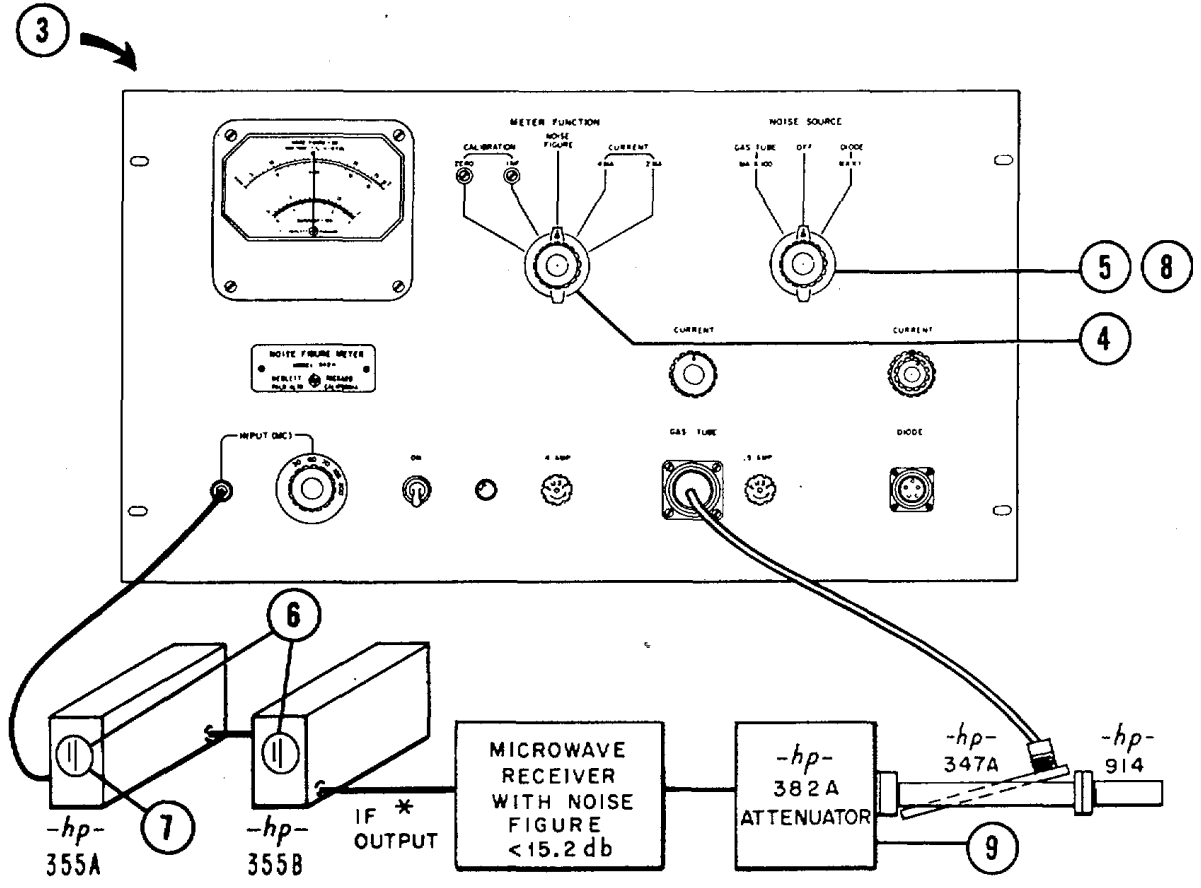

1. Measure Noise Figure as shown in Figure 2-5
 2. Connect equipment as shown above. Set all attenuators to zero.
 3. Turn NOISE FIGURE switch (rear of 342A) to MANUAL.
 4. Set to NOISE FIGURE.
 5. Set to OFF.
 6. Adjust attenuator for convenient reference reading $> 1/4$ scale.
 7. Add 3 db attenuation. *
 8. Turn to GAS TUBE.
 9. Adjust 382A for reference reading of step 6.
 10. NF: See Paragraph 3-2.
 11. Step 1 and step 10 should agree within the specified accuracy of the 342A \pm accuracy \oplus 382A and \oplus 355A.
- * Correct for impedance mismatch if Receiver IF Amplifier output is other than 50 ohms and 355B is set for less than 20 db.

Figure 4-3.

4-4. TUBE RIEPLACEMENT

The following Table 4-1 lists the vacuum tubes by circuit reference number, and indicates adjustments that may be necessary after replacing tubes.

TABLE 4-1. TUBE REPLACEMENT CHART

Tube	Adjustment or Check Required
V1-4 V5	Adjust + 250 v regulated (par. 4-6B) Measure -150 v ± 5 v. I ary line voltage $\pm 10\%$, change of voltage should be less than ± 1 v
V6, 7 V8-10	Retune coils L7 - L11 (par. 4-6D) Retune coils on each side of tube replaced, (par. 4-6C)
V101, V102	Adjust filament voltage (par. 4-6A) and check ZERO and DIF for proper operation
V 103 V104	Check operation of AGC (par.4-6D) Measure plate waveform, peak-to-peak amplitude = 175 v $\pm 20\%$ (140 v to 210 v)
V 105	No check required if instrument operates
V 106	Measure plate waveform, peak-to-peak amplitude = 185 $\pm 20\%$ (14L8 v to 222 v)
V107 V 108, V 109	Check diode current range (par. 2-21D) Connect a 250 ma 347A Waveguide Noise Source (preferably an S347A) and check that maximum current is at least 250 ma at 103 volt line
V 110, V 111	Check DIODE CURRENT AD. (par. 2-2D) and regulation. 10% change of line voltage should not change diode current more than 5%, O.D.15 ma at 3 ma)

Tubes with standard EIA (JEDEC) characteristics can be used for replacement. In a great number of cases, instrument malfunction can be traced to a defective or weak tube. Check tubes by and replace only those proven to be weak or defective. Mark original tubes to insure their being returned to the same socket if not replaced. Results obtained by the use of a "tube checker" can be erroneous and misleading. You are urged to check tubes before changing any internal control settings. Adjustments that are made in

an attempt to compensate for a defective tube or circuit component will often complicate a repair problem. You can usually save time and avoid complete instrument readjustment by repairing an instrument without changing any of the internal adjustments.

4-5. ADJUSTMENTS

Model 342A has few adjustments which cannot be made from the front panel. The internal adjustments affect only the Power Supply, Mixer, Oscillator, and IF Amplifier.

The specifications for the 342A are given in the front of this manual The following test procedure contains extra checks to help you to analyze a particular instrument. This additional data should not be considered as specifications.

When performing the following adjustments, set the line voltage to the 342A at U5 volts, unless otherwise stated. This may be done by using a metered variable autotransformer with a 4 ampere rated current If a metered autotransformer is not available, a general purpose multimeter (VOM) may be used to monitor the power line voltage. The multimeter should be calibrated to 2%.

A. FIL ADJ. R4

1) Connect an ac voltmeter accurate within $\pm 2\%$ such as an V Model 400D, between pins 2 and 4 of the ballast tube, RTL (Pin 4 is used as a tiepoint for the -150 volts).

CAUTION

These points are -150 volts from ground, so the meter used must be isolated from the 342A chassis and from the power line ground.

2) Adjust R4 for 6. 3 volts rms.

3) Vary the line voltage from 103 to 127 volts. The meter reading generally will vary less than 0. 2 volt from 6. 3 volts. If variation is greater than 0. 2 volts, this condition may possibly be eliminated by replacing the ballast tube, RT 1.

B. +250VDC ADJ. R16

This regulated power supply will require infrequent adjustment. The output voltage should be measured at regular intervals with an accurate voltmeter but unnecessary adjustments should be avoided. If the power supply voltage is regulated within ± 1 v, do not make adjustments in an attempt to refine the

Model 342A

existing setting of R16, unless the absolute value of the + 250 v line is greater than +2%. If it is necessary to reset the + 250 vdc, use the following procedure:

- 1) Connect a +2% dc voltmeter, such as a recently calibrated - Model 410B, between chassis and cathode (pin 6) of V2.
- 2) Adjust R16 for + 250 volts.
- 3) Check the regulation by varying the power line voltage from 103 to 127 volts. The dc voltmeter reading variation should be less than +1 volt. If greater, check tubes V 1 through V4.

C. TUNING THE AMPLIFIER COILS

- 1) Set the 342A line voltage to 103 volts. Connect an Model 608D VHF Signal Generator (or its equivalent) to the 342A INPUT. Set the 608D frequency for a 30 mc CW output using the internal crystal calibrator. Adjust the output to "Set Level" which will calibrate the output attenuator for absolute readings in dbm.
- 2) Adjust the 342A INF potentiometer fully clockwise. set thle MTER PrTr-TION to NOISE FIGURE, and the INPUT (MC) switch to 30.
- 3) Peak coils L17 through L20 for maximum 342A meter reading. Alternately reduce the signal from the 608D, using its output attenuator, and peak the coils. Repeat this procedure until all of the IF stages are tuned.
- 4) After the coils are tuned, the sensitivity for a full scale reading should be at least -60 dbm. An open coil or a dead tube will cause a 15 to 20 db loss in sensitivity. I the 342A meter remains at full scale with no input signal, spurious oscillation may exist. Check tubes and circuit components if oscillation occurs.

D. TUNING THE LOCAL OSCILLATOR AND MIXER COILS

- 1) Before tuning the oscillator or mixer coils, the IF Amplifier coils must be tuned (see paragraph 4-6C).
- 2) Follow the same procedure as outlined in paragraph 4-6C 1) except set the 608D frequency and the 342A INPUT (MC) switch to 60, 70, 105 and 200 mc.
- 3) Peak the oscillator and then the mixer coil for each frequency for maximum 342A meter reading. Alternately reduce the signal generator output, using the output attenuator, and peak the coils. There 00801-3 will be some interaction between oscillator and mixer coil tuning so the adjustments should be repeated. After tuning, the sensitivity should be at least -60 dbm.

NOTE

Tuning of the IF Amplifier, Local Oscillator, and Mixer Coils should be done at low line voltage. The increased gain of the tubes when the heater is operated at normal line voltage will effectively offset the slight detuning of the amplifier caused by the Miller effect. In this manner the sensitivity of the system will tend to remain constant with line voltage variations within the specified operating range of the instrument.

E. CHECKING AGC ACTION

- 1) Set line voltage to 115 volts.
- 2) Connect a 30 mc CW signal from an - Model 608D (use calibrator) to 342A INPUT.
- 3) Set Model 608D output to -60dbm and adjust INV potentiometer for a 25db reading on the 342A meter.
- 4) Vary Model 608D output from -60 to -0 dbm; the 342A meter pointer should remain between 25 db and INF.

F. BINARY OUTPUT

These terminals, J105, are located inside the instrument on the main deck. The signal appearing at this point is the output from the binary tube, V106 (12AU7). The waveshape and amplitude are indicated in the schematic diagram. The amplitude normally will be within $\pm 20\%$ of the stated values. These terminals simplify checking of multivibrator and binary circuit operation.

4-6. CHECKING METER TRACKING

To check the 342A meter scale calibration, it is only necessary to set up series of pulses in synchronism with the binary output and means of adjusting a precisely known power ratio between two pulses, N1, noise source off, and N2, noise source on. Equipment required for this check is as follows:

- 1) A square-wave generator which can be externally synchronized, such as an S Model 211A;
- 2) a stable vhf signal generator, such as an O Model 606A;
- 3) A vhf attenuator calibrated to ± 0.1 db in 1 db steps from 1 to 11 db, such as an * Model 355A (typical accuracy of 355A at 30 mc is approximately 0.06 db);
- 4) a crystal detector, such as an , Model 420A; and
- 5) an oscilloscope with a high sensitivity of 1 millivolt/cm, such as an - Model 130B. Equipment connection is shown in _Figure 4-4

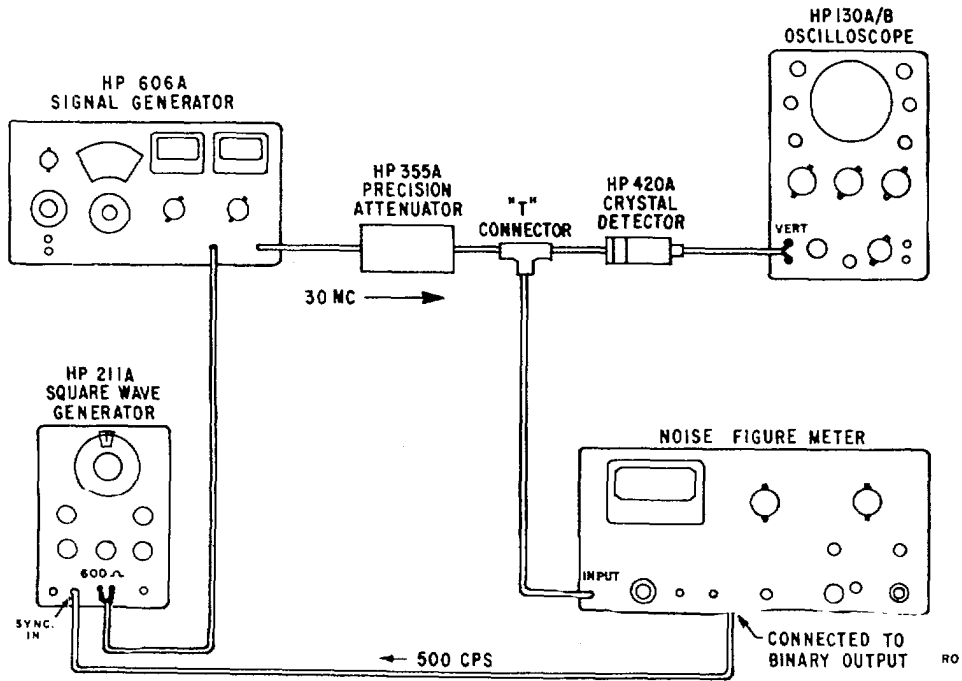

Figure 4-4. Test Setup for Meter Tracking

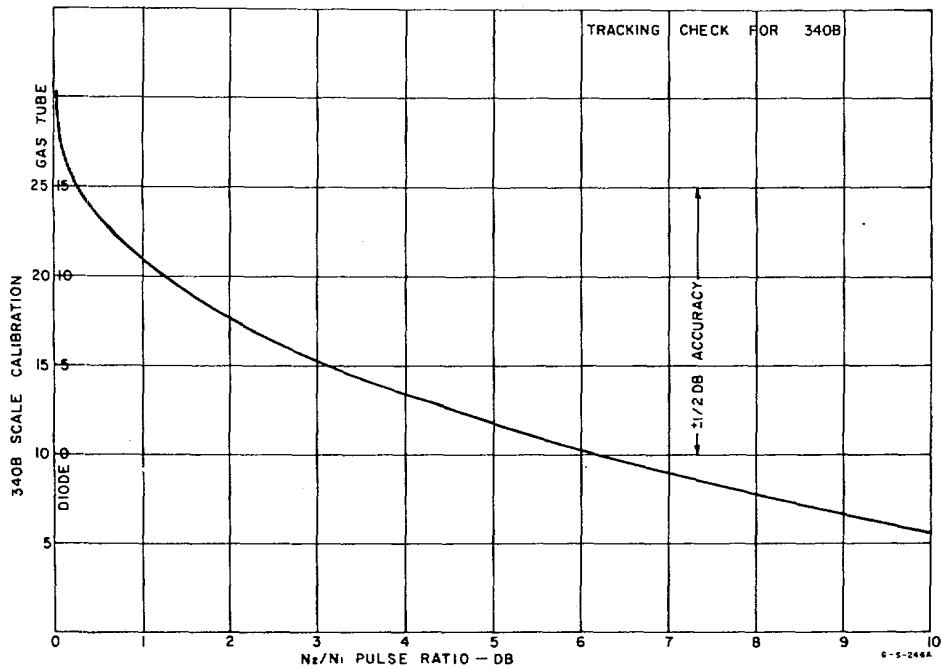

Figure 4-5. Scale Calibration vs Pulse Ratio

Model 342A

The 342A binary output jack(three terminals binding posts) located inside the instrument on the top of the chassis provides a synchronizing signal for the 211A Square Wave Generator. Either terminal A or B may be used and the correct terminal to be used is given in the procedure below. The negative-going half of square wave from 211A 600 ohms output is fed into the modulation input of 606A to provide a negative-going amplitude modulation during the time for which the N1 pulse (noise source off) is being sampled in the 342A. The positive- going half of the square wave from 211A represents the time of the N2 pulse (noise source on). The depth of the modulation of the N1 simulated pulse is adjusted by output amplitude control on the 211A. This gives a fine control on the amount of difference between the N1 and N2 pulses. The pulse ratio of N1 to N2 must be set very accurately in the procedure given below; as shown in Figure 4-5, which plots the 342A scale calibration in terms of the pulse ratio between N1 and N2. The curve is derived from the equation

$$NF_{db} = 15.2 - 10 \log_{10} \left(\frac{N_2}{N_1} - 1 \right)$$

Note that a ± 0.1 db inaccuracy in the setting of the N2 to N1 pulse ratio at a 3 db setting, which is the center of the scale, is equivalent to a $+0.25$ db inaccuracy on the 342A scale reading, and since the overall specification on the meter reading in the center of the range is ± 0.5 db it is important that the pulse ratio be accurately set.

Following is a step-by-step procedure for calibrating the 342A at 30 mc and -60 dbm. Other calibrations may similarly be done up to 65 mc and -20 dbm for full performance check.

1) Remove the rear cover of 342A. Connect equipment as shown in Figure 4-4; turn on equipment and allow warm up period of 30 minutes.

2) Set controls as follows:

211A Square Wave Generator. FREQUENCY dial on "4.25", RANGE switch to X100, SYMMETRY control to mid-position, and 600 a OUTPUT AMPLITUDE control to "0".

606A HF Signal Generator, FREQUENCY to 30 MC, MODULATION SELECTOR switch to EXT. DC, MODULATION AMPLITUDE control to mid-position, ATTENUATOR to -60 DBM, and output VERNIER control to set meter pointer of power monitor meter exactly on "0" DBM.

355A VHF Coaxial Attenuator. Set for 1 db of attenuation.

130B Oscilloscope. VERT. SENSITIVITY switch to 10 MILLIVOLTS/CM, VERT. AC-DC switch to DC, SWEEP TIME/CM switch to 2 MILLISECOND/CM, 00801- 2 HORIZ. SENSITIVITY switch to X1 INT. SWEEP, TRIGGER SLOPE switch to "-", and SYNC selector switch to INT.

342A Noise Figure Meter. INPUT switch to 30MC, METER FUNCTION to NOISE FIGURE, NOISE SOURCE to OFF, and NOISE FIGURE switch (located at rear of instrument) to AUTO.

3) Disconnect cable from 606A MODULATION INPUT-OUTPUT connector. On 342A, turn METER FUNCTION switch to CALIBRATION ZERO and adjust zero set; turn METER FUNCTION to CALIBRATION INF. and adjust infinity set.

4) Turn METER FUNCTION switch to NOISE FIGURE and reconnect modulation input cable.

5) Slowly advance the setting of 211A 600 /2 OUTPUT AMPLITUDE control. As 211A output amplitude is increased, the meter pointer of 342A meter should move down-scale (left) from INF. Marking towards "5" on the upper scale. If the pointer begins to move up-scale (right) from INF. marking, change 342A binary output connection to the other binding posts.

6) Turn 211A SYMMETRY control slowly to counterclockwise position and note any changes in the meter reading of 342A. If the reading changes then turn SYMMETRY control in the opposite direction and note any changes in the meter reading. The correct setting of 211A SYMMETRY control is when there are no changes noted in the meter reading.

7) Set 606A ATTENUATOR to 0 DBM; adjust 355A for 11 db of attenuation, and note the position of N1 and N2 pulses on the oscilloscope(see Fig. 4-6).

8) Turn 130B VERT. SENSITIVITY switch to 1 MILLIVOLT/CM; adjust VERT. POS. control to align the trailing edge of N2 pulse with center line of graticule (see Figure 4-6).

9) Adjust 355A for 1 db of attenuation; adjust 211A 600 Q OUTPUT AMPLITUDE to align trailing edge of N1 pulse with center line of graticule. Do not change the setting of 130B VERT. POS. and VERT. SENSITIVITY during this adjustment.

10) Set 606A ATTENUATOR to -60 DBM and record the reading on 342A meter.

11) Repeat the procedure given in steps 8, 9, 10, and 11 using 10 db and 1 db attenuation in 355A for ratio N2/N1 of 9 db; using 9 and 1 db attenuation for ratio N2/N1 of 8 db, etc. At ratios below 4 or 5db, it may be necessary to decrease the sensitivity of 130B to align N2 pulse level.

12) Compare the indicated noise figure with computed noise figure given below.

Ratio	Computed Noise Figure
10 db	5.66
9 db	6.79
8 db	7.95
7 db	9.18
6 db	10.45
5 db	11.85
4 db	13.40
3 db	15.22
2 db	17.57
1 db	21.07
0 db	INF

The computed Noise Figure is obtained from the following equation:

$$NF\ db = 15.2 - 10 \log_{10}(N_2/N_1 - 1)$$

and substituting N_2/N_1 from 0 to 10 db.

4-7. TROUBLE LOCALIZATION

Most failures in the 342A will be due to defective electron tubes. Use table 4-2 to help localize trouble. Compare voltages and waveforms in the unit to those shown on the schematic diagram to find the trouble.

Table 4-2. Trouble Localization Chart

Symptom	Possible Cause
Line fuse blows	Shorted CR2, 3, 4 or 5
Line fuse blows when gas tube is turned on	Short in cable or gas tube mount. Broken gas tube in noise source.
Gas Tube will not ignite	Shorted L101 Defective V108, 109 or tube in 347A. Open gas tube power cable. Blown F101
Insufficient gas tube current	Defective V106, 108 or gas tube in 347A noise source
Meter zero varies	+250 volt supply not regulating. Defective V1, 2, 3, and 4.
15-20 db gain loss in sensitivity	Defective tube in RF and IF Amplifier. Open coil in IF Amplifier
Meter pins with no input to 342A	Oscillations in Tuned Amplifier
Meter pins with usual input	No AGC. Check positions Noise Figure switch

00801-3

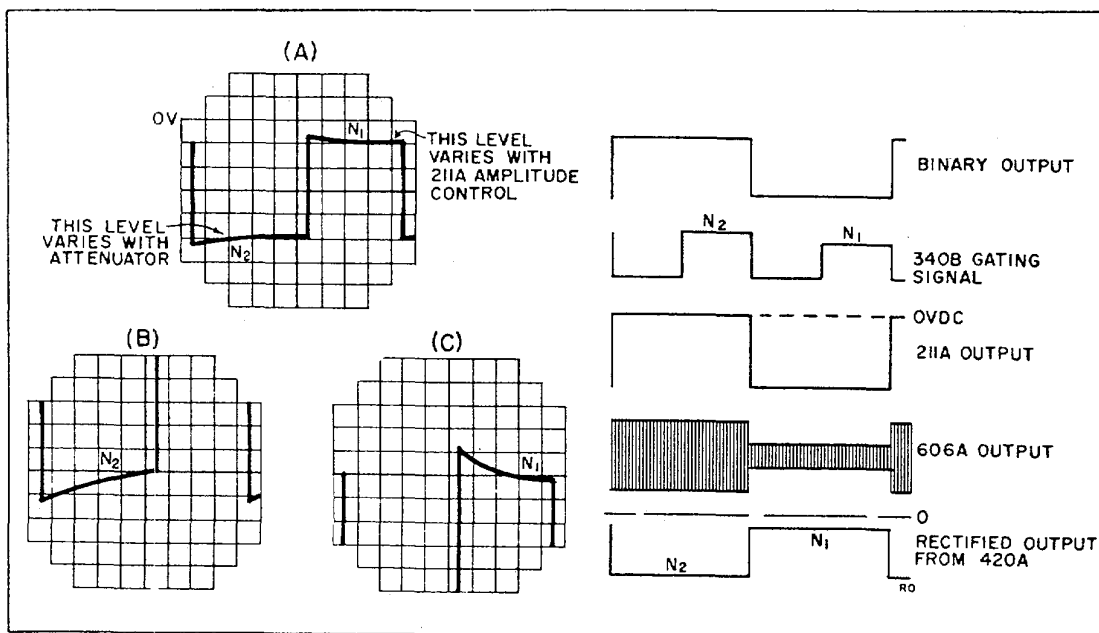

Figure 4-6. Waveforms

**SECTION V
NOISE SOURCE MODEL 349A**

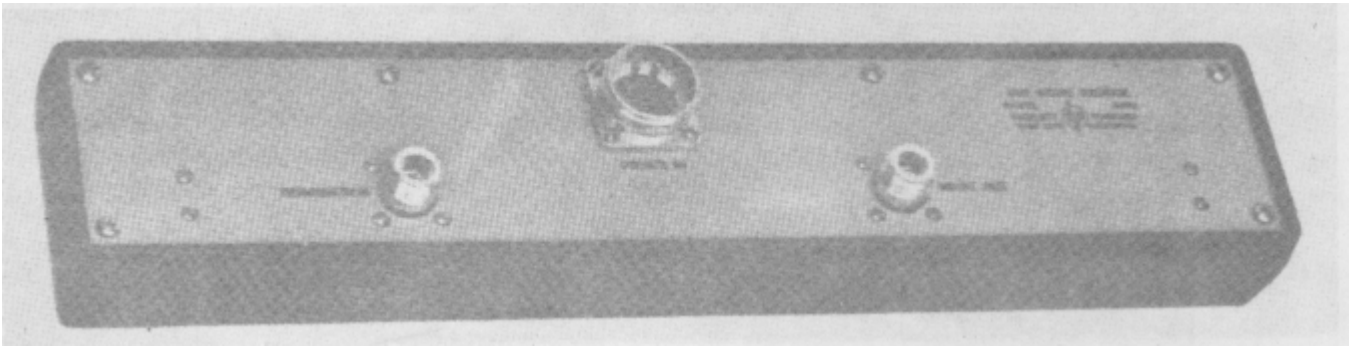

Figure 5-1. Model 349A Noise Source

5-1. INTRODUCTION.

Like other noise sources, the 349A is designed to operate from the internal power of the Models 340A/B or 342A Noise Figure Meters. The Model 349A is connected to a noise figure meter and the source current adjusted using the controls and meter provided on the noise figure meter. The source is then ready for operation.

5-2. GENERAL OPERATING INFORMATION.

CAUTION

Due to a capacitive effect between plasma and helix, a high voltage pulse appears at both the NOISE OUT and

TERMINATION connectors. This pulse occurs during the noise tube ignition interval. The energy from the pulse may damage fragile devices, such as parametric amplifiers or transistors. To protect equipment from these pulses, a suitable high-pass filter should be utilized.

The Model 349A Noise Source is designed for use with the Models 340A/B and 342A Noise Figure Meters. The noise source provides a known excess noise power throughout its spectrum. The output of the noise source is fed to the device under test and

Table 5-1. Specifications

FREQUENCY RANGE: 400 to 4000 Mc, wider range with correction	Meters
EXCESS NOISE 15. 7 0.5 db; 1000 to 4000 Mc 15. 6 0.6 db; 400 to 1000 Mc	MAXIMUM RF INPUT Voltage: 225 volts peak Power: 1000 wafts peak, . 5 watts average
NOISE GENERATOR: Argon discharge tube	NET WEIGHT: Approximately 3-1/4 lb (1, 5 kg)
RECOMMENDED OPERATING CURRENT: 150 n	SIZE: 15 inches (381 mm) long, 3 inches (76 mm) wide, 2 inches (51 mm) high
SWR:	NOISE OUT and TERMINATION Connectors: Type N, terminate one end with a 50-ohm low-reflection coaxial load except it feed-through5-1 applications
Up to 2600 Mc: <u>Fired</u> <u>Unfired</u>	ACCESSORIES AVAILABLE: 908A Coaxial Termination, 50 ohms
2600 to 3000 Mc: less than 1.35 less than 1.	
3000 to 4000 Mc: less than 1.5 less than 1	
Source terminated ina coaxial load with less thi 1.05 SWR	
INPUT POWER: Supplied by V Models 340A'B or 342A Noise Figure	

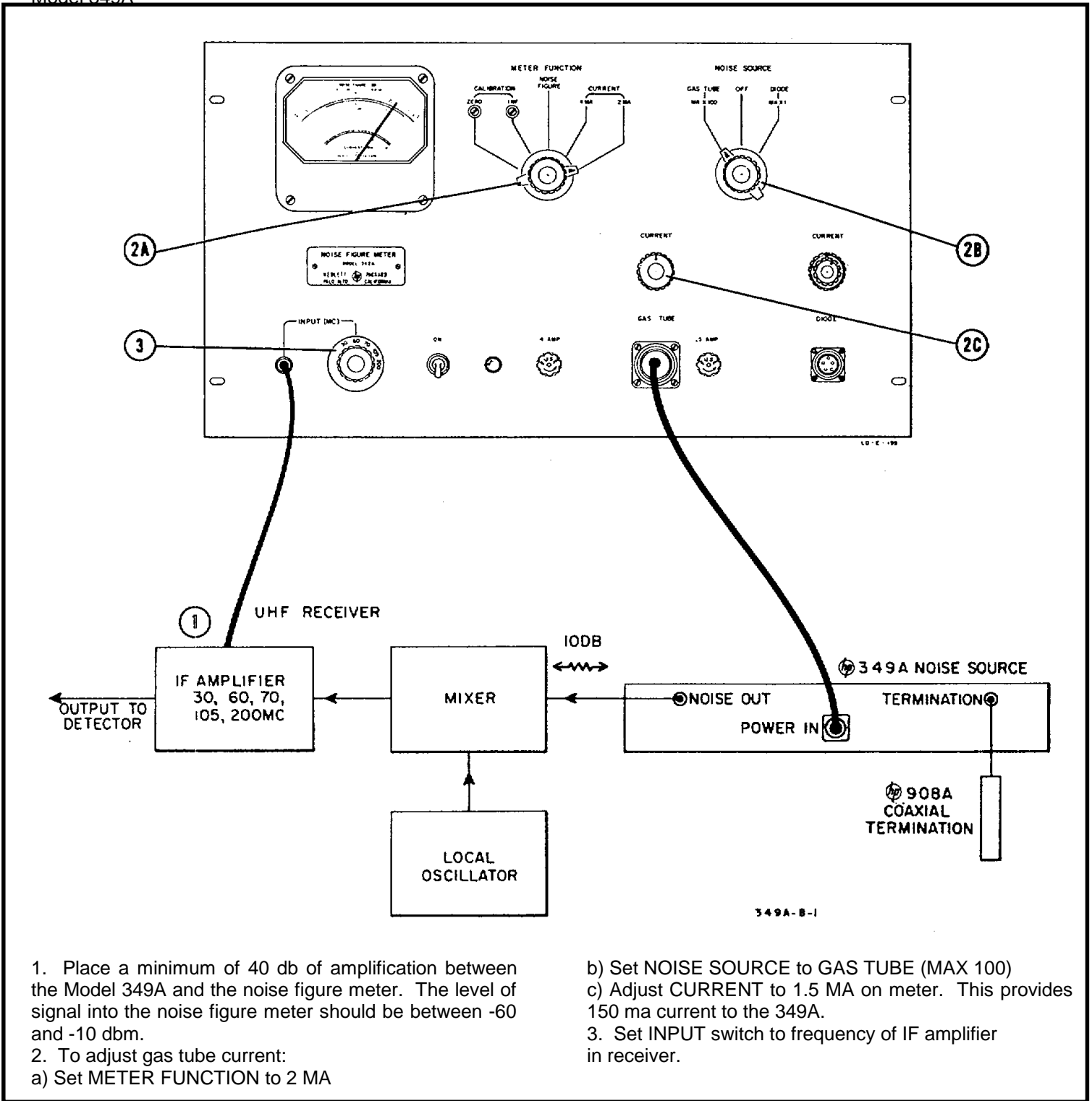

1. Place a minimum of 40 db of amplification between the Model 349A and the noise figure meter. The level of signal into the noise figure meter should be between -60 and -10 dbm.
2. To adjust gas tube current:
 - a) Set METER FUNCTION to 2 MA

- b) Set NOISE SOURCE to GAS TUBE (MAX 100)
- c) Adjust CURRENT to 1.5 MA on meter. This provides 150 ma current to the 349A.
3. Set INPUT switch to frequency of IF amplifier in receiver.

FIGURE 5-2. Setup for Measuring Noise Figure Using UHF Noise Source

Model 349A

by means of a square-wave modulating voltage, supplied by the noise figure meter, the noise source is alternately turned on and off. The noise figure of the device under test is measured by comparing the noise output of the device under test when the noise source is "on" to the noise output of the device under test when the noise source is "off". The noise figure meters make this measurement automatically.

5-3. OPERATION.

a. Connect the NOISE OUT terminal of the Model 349A to the input of the device under test. Inserting a 10-db pad between the Model 349A and the device under test results in the following advantages:

(1) Increased readability of noise figure. With 5.7 db excess noise (noise source output of 15.7 db minus 10 db), noise figure can be read on the DIODE (expanded) scale.

(2) Better impedance match of noise source to system.

(3) More constant terminating impedance for device under test; this is important when working with a parametric amplifier as it needs a constant terminating impedance for proper operation.

b. Terminate the jack labeled TERMINATION with a 50-ohm low SWR load.

c. Using the 340A-16A cable supplied with the noise figure meter, connect the seven-pin POWER IN connector on the Model 349A to the GAS TUBE connector on the noise figure meter.

d. Connect the IF output of the device under test to the noise figure meter, and operate the controls as indicated in Fig. 5-2. Make the noise figure measurements as described in the Operating and Service Manual for the noise figure meter in use.

Note

For optimum operation, the noise source tube must be operated at 150 ma. The measured noise figure will vary less than 0.1 db due to gas tube current change of +/-10%.

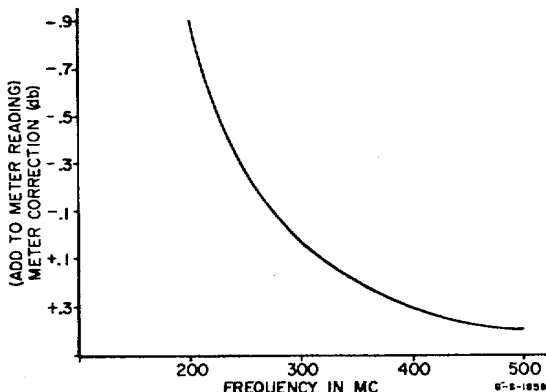

Figure 5-3. Model 349A Noise Source, Typical Correction for Hot-Cold Loss at Low Frequencies
CORRECTION FOR EXCESS NOISE.

Since the * Models 340A, 340B, and 342A Noise Figure Meters are calibrated for use with a noise source having 15.2 db excess noise, a correction factor must be added to all noise figure meter readings. Correction is arrived at by subtracting 15.2 db from the actual noise output of the noise source. For the 349A the following corrections apply:

a. At frequencies between 1000 Mc and 4000 Mc add +0.5 db to noise figure meter reading.

b. At frequencies between 500 Mc and 1000 Mc add +0.4 db.

c. At frequencies below 500 Mc refer to Figure 5-3.

FEED-THRU APPLICATION.

Since the power of most transmitters is such that the noise source cannot be connected directly into the transmission line, it must be connected to the receiver input. In Fig. 5-4 the noise source is connected between the TR switch and the receiver. The transmitter must be off for noise figure measurements.

If the transmitter is on, erroneous noise figures may be obtained.

5-4. PRINCIPLES OF OPERATION.

The Model 349A Noise Source consists of an argon-filled gas tube coupled to a transmission line in the form of a helix. "T"-type filters are present in the power leads to the cathode and anode of the tube. These filters prevent feedback through the power supply to the noise figure meter. The noise source is housed in an aluminum container and has jacks for power input and signal output.

The gas tube is alternately turned on and off by a square-wave modulating voltage supplied by a noise figure meter. When a pulse is applied to the gas tube, the gas in the tube ionizes and excess noise is generated. The noise is coupled by means of a helix to the NOISE OUT and TERMINATION connectors of the noise source. The helix must be terminated in its characteristic impedance which is 50 ohms.

5-5. PERFORMANCE CHECKS.

TEST EQUIPMENT.

Test equipment recommended for use in checking performance of noise source is listed in Table 5-2. Equipment having similar characteristics can be substituted for the equipment listed. Performance check procedures given include test setups and required specifications. For more details, the operator must refer to the respective equipment manual. The test limits given in the following do not account for possible instrumentation errors such as directional coupler mismatch, detector mismatch and deviation from square law response, and oscilloscope attenuator errors. These errors will normally cancel each other out and should not materially affect the results achieved. The techniques involved in the elimination of these errors are beyond the scope of this Note and will not be discussed.

TABLE 5-2. Test Equipment

Quantity	Type	Critical Specifications	Recommended Model
1	Sweep Oscillator	Frequency Range: 1.0 to 4.0 Gc Level Output Capability: A0.3 db PWR OUT: 20 mw	691 and 692 or 682C & 683C with HO1- 4401A Leveler Amplifier
1	Sweep Generator	Frequency Range: 400 to 1000 Mc Level Outpt Capabiity: i0. 5 db PWR OUT: 30 mw	Jerrold 900A/B
1	Dual Directional Coupler	Frequency Range: 400 to 4000 Mc Directivity: 40 db (1.9to 4.0 Gc: 30 db) SWR: Less than 1.5	774D/775D/776D/777D
1	Crystal Detector	Frequency Range: 400 to 4000 Mc SWR: 1.2 Sensitivity: About 0.2 mv dc -lw	423A
1	Crystal Detector and Square-Law Load	Frequency Range: 400 to 4000 Mc8 SWR: 1.2 Sensitivity: 50 mv for 0.2 mw input Sq Law Response: 0).5 db (up to 50 mv)	423A with Option 02
1	Coaxial Termination	Frequency Range: 400 to 4000 Mc4 SWR: 1.05	908A
1	Oscilloscope	Frequency: DC to 10 kc Vertical Sensitivity: 0. 2 mv/cm and 10 mv/cm Vertical Attenuator Accuracy: +3%	130C
1	Coaxial Short	Type N male	11512A
1	Signal Source	Frequency Range: 450 to 4000 Mc PWR OUT: 5 mw Capable of internal sine wave or square wave modulation (1000 cps), and CW operation	612A/8614B/8616B
1	Slotted Line	Frequency Range: 450 to 4000 Mc SWR: Less than 1.05	805A/C
1	SWR Meter	'Accuracy: 3A% Sensitivity: 0.2 jiv Frequency: 1000 cps	415B/D
1	Fixed Attenuator	Attenuation: 10 db Frequency Range: 400 to 4000 Mc SWR: 1.20 Maximum Variation Across Band: 0. 7 db	Weinschel 650-10

SWR CHECKS.

- a. Set up test equipment as shown in Figure 5-5. Note: It is important that the front panel connectors be free of dust, dirt, and any other foreign matter.
- b. Disconnect the 340A-16A cable from the POWER IN Connector.
- c. With the RF output of the sweeper cut off, set the Oscilloscope for a DC-coupled zero reference line on the 10 mv/cm range.
- d. Connect the short to the coupler and adjust the RF output so that all portions of the oscilloscope display produce a 5-cm or larger deflection. Remove short and readjust RF output if necessary so that all portions of display still produce a 5-cm or larger deflection.
- e. Cut off RF output and switch Oscilloscope to appropriate range for required return loss measurement

(see Table 5-3. Using VERNIER control on Oscilloscope, reset zero reference line if switching Oscilloscope range has caused a zero shift.

- f. Connect NOISE OUT connector to Coupler and Coaxial Termination to TERMINATION connector. Note: TERMINATION connector must be terminated with a 50-ohm load with less than 1.05 SWR.
- g. Switch RF output on to the same level as in step d and measure deflection caused by return loss. Specification: deflection line must be equal to or less than deflection listed in Table 5-3 if any point is questionable a spot check and calibration of that point alone must be made. The RF output level should be adjusted at the single frequency in question so that the average of the deflection with a short- and open-circuit is 5 cm.

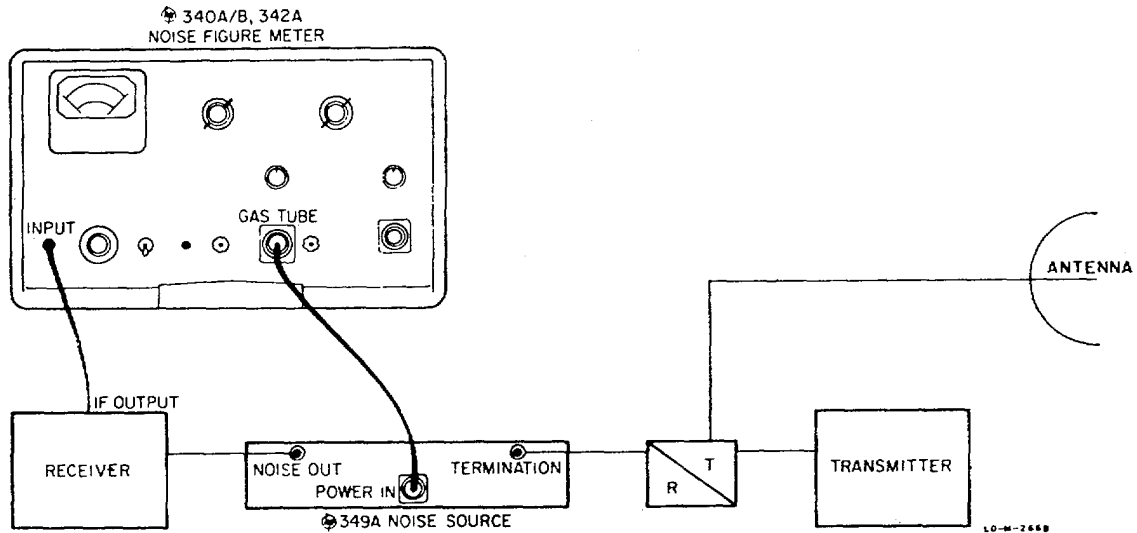

Figure 5-4. Noise Figure Measurement in a Feed-Through application (Noise Source Protected by TR Switch)

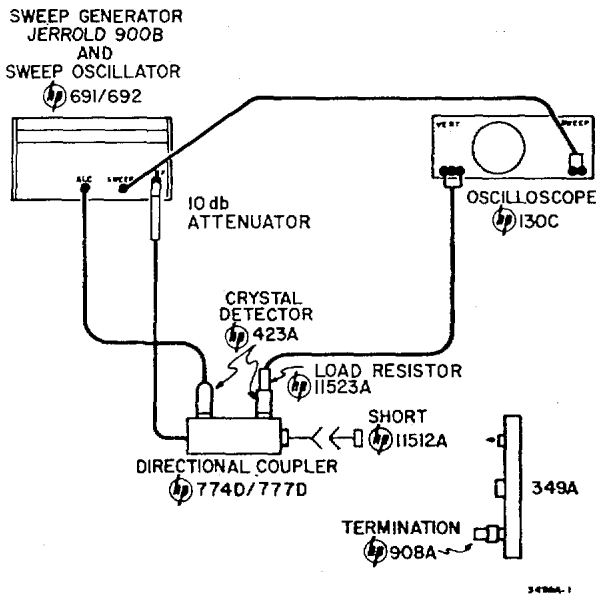

Figure 5-5. SWR Indication

TABLE 5-3. SWR Indication

SWR Specification	Oscilloscope Range	Maximum Oscilloscope Indication
1.35	0. 2 mv/cm	5.6 cm
1.5	0.5 mv/cm	4.0 cm
2.0	1.0 mv/cm	5.5 cm
3.0	2.0 mv/cm	6.2 cm

h. If measured SWR is at any point not within specifications, it will be necessary to remove noise source top plate (see Para 5-5) and adjust tube

position by rotation of tube in RF housing. On rare occasions it may also be necessary to adjust lateral tube position but only slightly. Adjust tube position until SWR is within specification.

i. Replace top plate in noise source and recheck SWR. Replacing and securing the top plate and tube in noise source may cause the SWR to change.

Note

Some tubes, although in excellent condition, cannot be adjusted to bring SWR within specification at all points: these tubes may be returned to the Hewlett-Packard Company or to your local field office for replacement.

j. Connect 340A-16A cable to POWER IN connector and fire tube (see Paragraph 5-3).

k. Repeat calibration steps c, d, e, and f.

m. Switch RF output on and note Oscilloscope display. Adjust PULSE RATE ADJ on rear of Noise Figure Meter until Oscilloscope display becomes nearly synchronized (a slow drift in display is desirable).

n. Measure deflection caused by return loss. Note: only the last half of the fired portion of the pulse-modulated noise source output need meet the required SWR specification (by turning the Noise Figure Meter NOISE SOURCE switch from GAS TUBE to OFF and back to GAS TUBE it is possible to note which portion of the observed display is the fired portion).

WARNING

ALWAYS disconnect cable to POWER IN connector before removing 349A top cover.

Model 349A

p. Typically when the unfired SWR meets specification the fired SWR meets specification but, if not, steps h and must be repeated.

q. If adjustment of tube was necessary to meet fired SWR specification, then the unfired SWR must be checked.

INSERTION LOSS CHECKS.

a. Connect a sine-wave or square-wave-modulated Signal Source to a Slotted Line.

b. Connect NOISE OUT connector to opposite end of Slotted Line.

c. Connect detected output of Slotted Line to SWR Meter and attach a Coaxial Short to TERMINATION connector.

d. DO NOT connect any cable to the, POWER IN connector.

e. Adjust Slotted Line for a minimum indication on SWR Meter. Set any convenient reference on SWR Meter.

f. Switch SWR Meter to a range 10 db greater than range used in step e.

g. Adjust Slotted Line to a point, as indicated on SWR Meter, as close to the minimum as possible but 10 db above it. Record the 10 db point by noting Slotted Line carriage position.

h. Adjust Slotted Line to a point as close to the minimum as possible and also 10 db above it, but, on the opposite side. Record this 10 db position.

i. The maximum distance between the closest 10 db points on either side of a minimum must be 33.9 mm at 500 Mc, 8.5 mm at 2000 Mc, 11.3 at 3000 Mc. and 8.5 mm at 4000 Mc.

j. Disconnect Slotted Line and SWR Meter and remove from setup.

k. Connect a CW Signal Source to NOISE OUT connector and a 20-db fixed attenuator or a terminated Directional Coupler to the TERMINATION connector.

m. Connect a high sensitivity Detector/Square-Law Load and Oscilloscope combination to the fixed attenuator (or to the secondary arm of the Directional Coupler.

n. Set Signal Source to 450 Mc. Switch RF output off and set a DC-coupled zero reference line on the 10mv/cm range of the Oscilloscope.

p. Switch RF output on and adjust RF output for a 5 cm deflection.

q. Switch Oscilloscope to 0.5 mv/cm range and RF output off. Reset zero reference line if it has been lifted by the change in Oscilloscope ranges.

r. Connect 340A-16A cable to POWER IN connector find fire 349A (see Para 5-3). With RF output unchanged from step p, observe deflection during last half of the time the 349A is fired. The maximum deflection should be 5 cm.

s. Repeat steps p through r1 at 600 and 1000Mc with the exception that the maximum deflection at these Frequencies should be 3.2 cm.

GAS TUBE REPLACEMENT.

WARNING

RADIOACTIVE MATERIAL - AVOID BREAKING TUBE. This tube contains a slight amount of radioactive material. The substance, if ingested, could cause personal injury. Contact your local USAEC Licensed RF radioactive Waste Disposal Agency for instructions in handling, storing, and disposal of these tubes.

To replace tube, proceed as follows:

a. Disconnect 340A.16A cable from POWER IN connector.

b. Remove four corner Phillips head screws and two Phillips head screws opposite TERMINATION and NOISE OUT jacks on top of instrument.

c. Lift top plate up and out.

d. Loosen Allen screw holding cathode insulator (see Figure 5-6).

e. Slide cathode insulator out from metal block.

f. The gas tube will now slide out through hole the insulator was in.

g. Insert new tube.

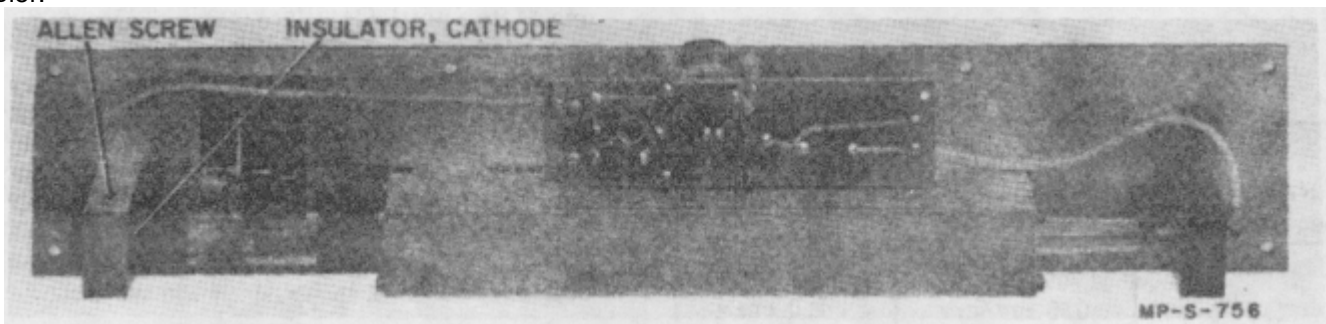

FIGURE 5-6. Internal View of Model 349A

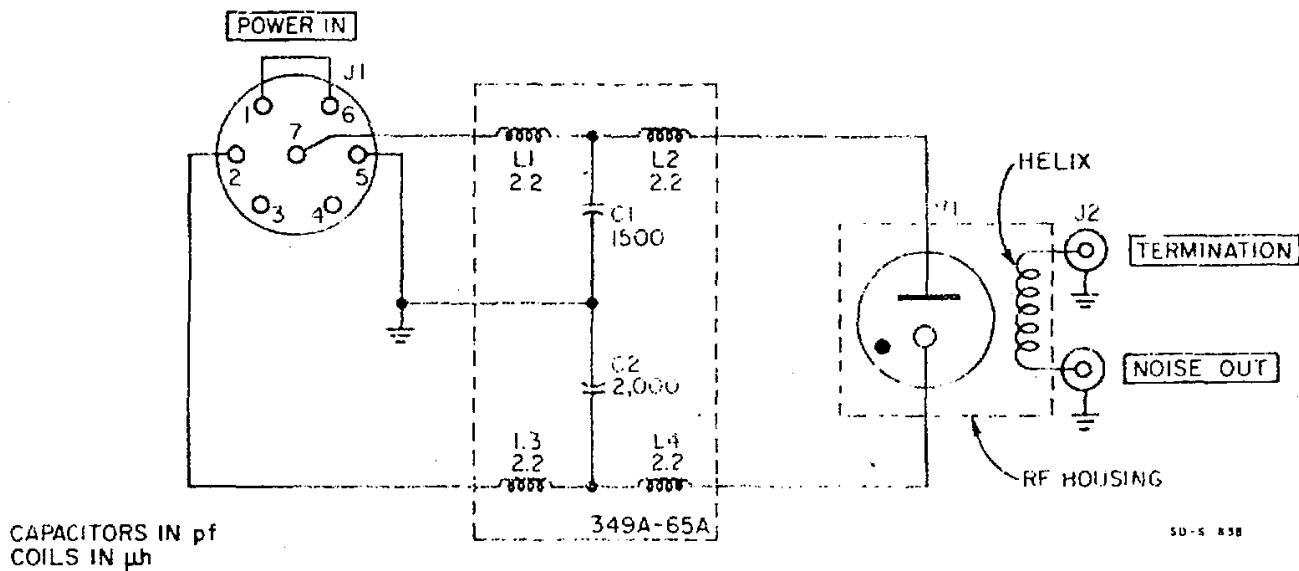

FIGURE 5-7. Model 349A Noise Source

h. Insert insulator and gently push insulator, towards tube. This will insure good electrical and mechanical contact. One end of tube holder is spring loaded and spring must be compressed slightly in order to be effective. Tighten Allen screw.

Replace top plate in case and replace screws. Be sure to snug screws as RF leakage may occur if screws are not tight. j. Tube replacement usually requires recalibration of instrument (refer to Paragraph 5-5).

FILTER COMPONENTS.

The filter components will give little trouble. The filter inductors can be checked for continuity with an ohmmeter. The capacitors can be checked by substitution for open capacitors or with an ohmmeter for shorted capacitors (see Figure 5-7).

By Order of the Secretary of the Army:

HAROLD K. JOHNSON,
General, United States Army,
Chief of Staff.

Official:

KENNETH G. WICKHAM,
Major General, United States Army,
The Adjutant General.

Distribution:

Active Army:

USAMB (1)

USACDCEC (1)

USACDCCEA (1)

USACDCCA Ft Huachua (1)

Eighth USA (5)

SAAD (5)

TOAD (5)

LEAD (3)

NG: None

USAR: None

For explanation of abbreviation used, see AR 320-50.

*US GOVERNMENT PRINTING OFFICE: 1995 - 388-421/01594

Model 342A

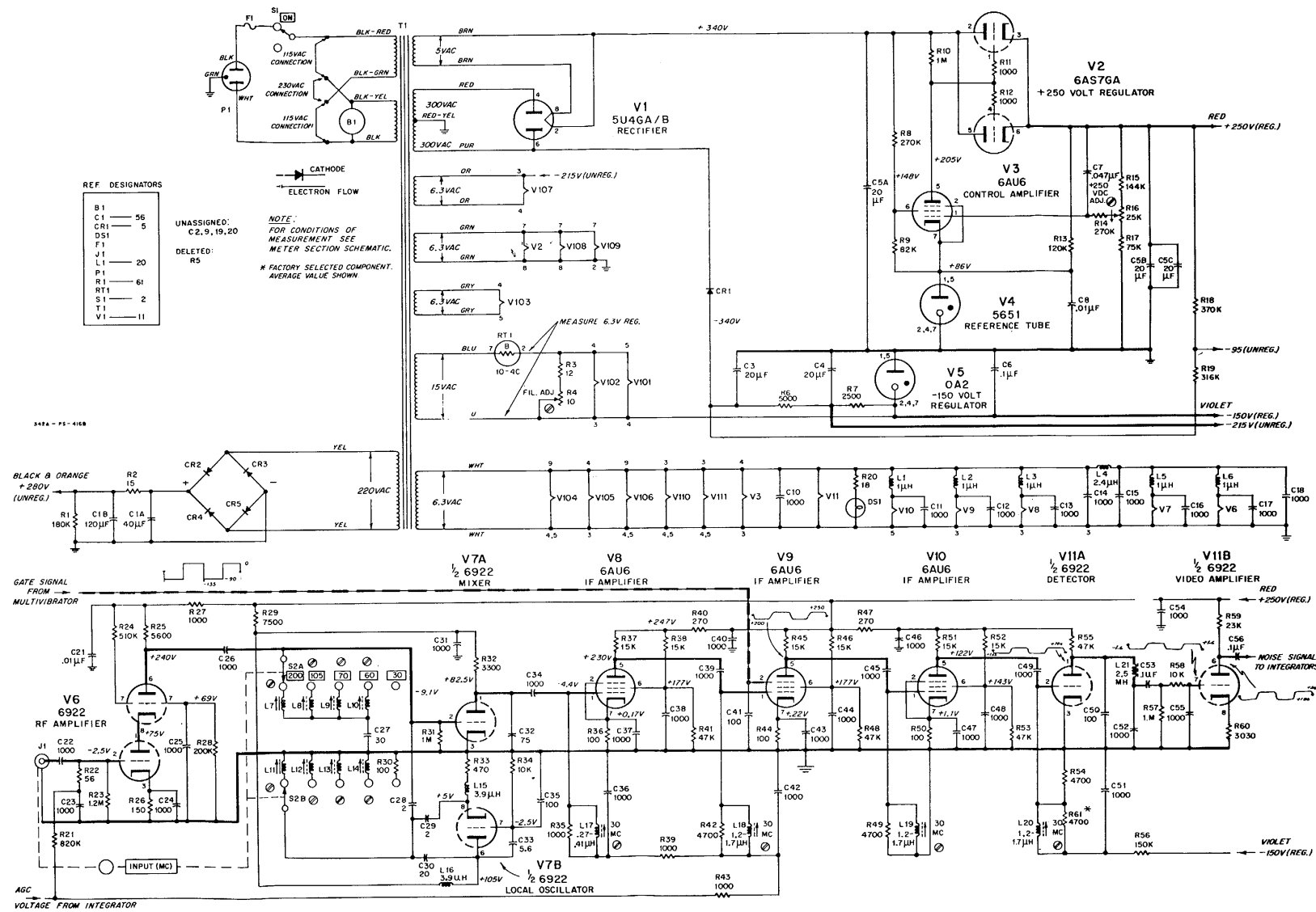

00801-3

Figure 4-7. Power Supply and Input Amplifier

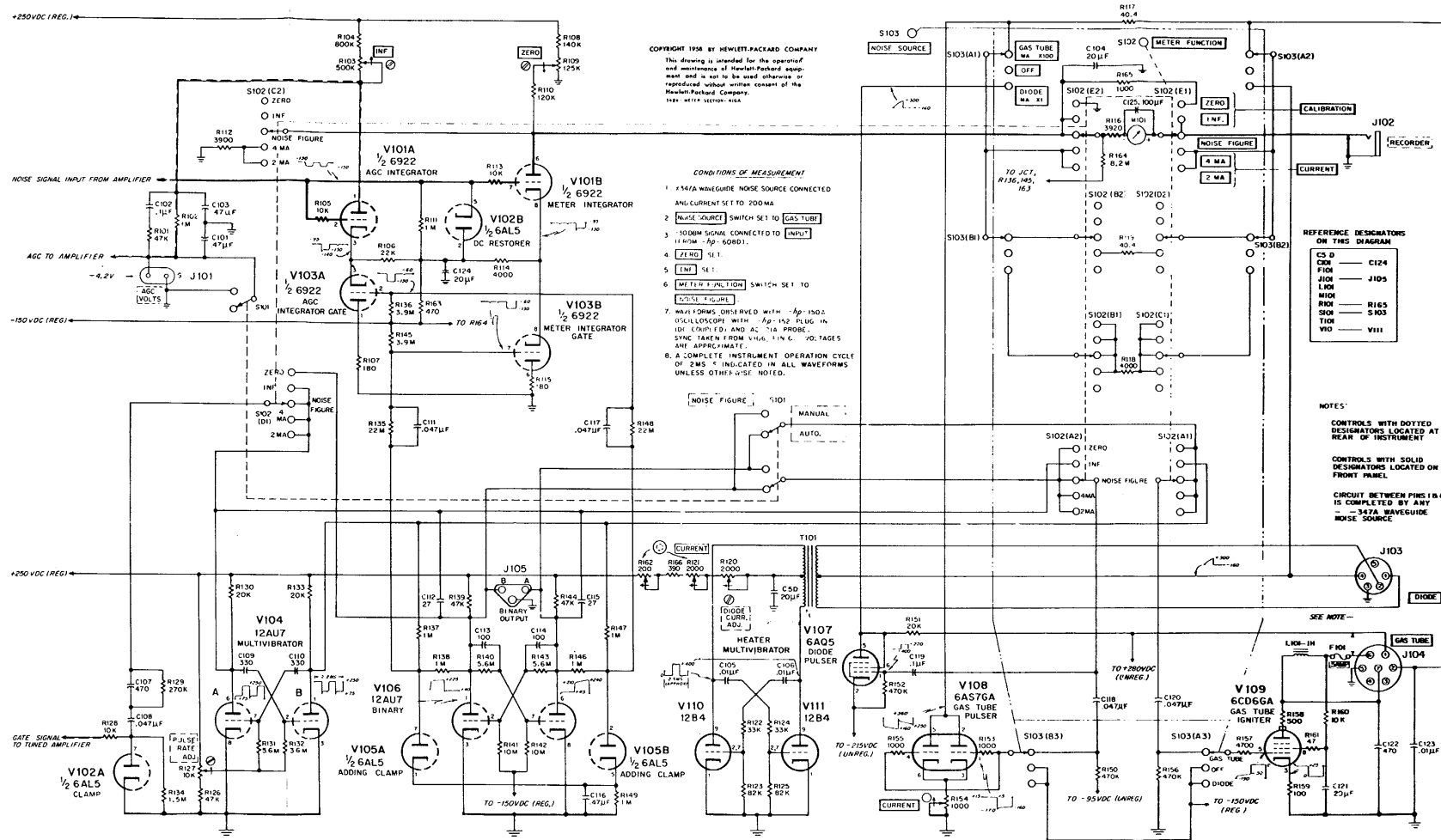

Figure 4-8. Meter and Timing Circuit

